

## **Assessments of the Southern Hemisphere humpback whale Breeding Stock B: Results for the models and sensitivities proposed at and following the 62<sup>nd</sup> meeting of the Scientific Committee of the IWC**

A. MÜLLER, D.S. BUTTERWORTH AND S.J. JOHNSTON<sup>1</sup>

Contact e-mail: [andrea.muller@uct.ac.za](mailto:andrea.muller@uct.ac.za)

### **Abstract**

This document reports on the results of several models and sensitivities proposed at the 62<sup>nd</sup> meeting of the Scientific Committee (SC) of the IWC for the assessment of the Southern Hemisphere humpback whale Breeding Stock B, as well as some additional models and sensitivities that were proposed intersessionally. These models and sensitivities explore various stock structure hypotheses and alternative input data. Prior incoherence resulting from the implementation of genetic  $N_{min}$  constraints was found to be a problem throughout the analyses, and the preferred way of including these constraints was the use of a global  $N_{min}$  constraint for the Gabon and WSA regions combined. The estimated intrinsic growth rate for B1 ranges from 0.039 to 0.052 for the main models and 0.043 to 0.069 for B2. The estimated 2010 abundance relative to pristine level ranges from 0.508 to 0.750 for B1, and 0.045 to 0.124 for B2.

### **INTRODUCTION**

The Southern Hemisphere humpback whale Breeding Stock B (BSB) is found off the west coast of Africa. At the 62<sup>nd</sup> meeting of the Scientific Committee of the IWC in Agadir, 2010, several stock-structure models were put forward for the assessment of BSB. Three of these were identified as high priority models and form the reference case models for the results presented in this document. Six further models were put forward (at the meeting and intersessionally), as well as several sensitivities to test alternative input data selections and catch allocation assumptions. This document presents the results of these models and sensitivities. Brief model descriptions are given in the Methods section, while detailed diagrams and model dynamics are given in Appendix 1.

Capture-recapture data and  $N_{min}$  constraints from genetic data are available for two regions: the waters off Gabon, and off West South Africa (WSA). Historic catches are from both these regions and off Antarctica (20°W-30°E). The proposed models explore various hypotheses regarding stock structure and make different assumptions in regard to which population or component of a population is to be found in each of the two regions. Each model gives an estimate of the number of whales found off Gabon and off WSA, and it is to these numbers that the capture-recapture data and  $N_{min}$  constraints apply.

### **DATA**

Appendix 2 lists the historic catch and capture-recapture data used for these analyses.

#### **Historic catch data**

There are two sources of historic catch data that relate to BSB, which are available from Allison's database (C. Allison, *pers. commn*)

- i) Catches north of 40°S

These catches have been split into catches taken in the waters off Congo, Congo/Angola, Angola, Namibia and West South Africa. Records of a series of Russian catches are also available by 10 degree longitude and latitude bands.

There are two series implemented in the assessments presented in this document. The reference case assumption allocates catches from Congo, Congo/Angola and Angola (50%) to the Gabon population, and Angola (50%), Namibia and WSA to the WSA population. The alternative hypothesis allocates catches from

---

<sup>1</sup> MARAM (Marine Resource Assessment and Management Group), Department of Mathematics and Applied Mathematics, University of Cape Town, Rondebosch, 7701, South Africa

Congo and Congo/Angola to the Gabon population, and Angola, Namibia and WSA to the WSA population. Both these catch series are presented in Appendix 2, Table A2.1.

The Russian catches were taken off Namibia and WSA and have thus been allocated to the WSA population for both hypotheses. These catches are presented in Appendix 2, Table A2.2.

ii) Catches south of 40°S0

This series refers to 100% of the catches recorded for the core area 10°W-10°E, 50% of the catches from the breeding stock A/B margin area of 20°W-10°W and 50% of the catches from the breeding stock B/C margin area of 10°E-30°E. These catches thus include both Gabon and WSA whales and are reported in Appendix 2, Table A2.3.

### **Absolute abundance estimates**

Photographs and biopsies were collected from four field sites on the coast of Gabon during the austral winter (July-October) in each year between 2001 and 2006, and data from two sites (Iguela and Mayumba) were analysed (Collins *et al.*, 2008). An absolute abundance estimate for Gabon is available from the application of MARK to the photo-ID (fluke) capture-recapture data from Iguela only (lower estimate of 6432 in 2003, CV=0.18) and the genetic data from Iguela only (upper estimate of 7196 in 2003, CV=0.15). Recent capture-recapture data for WSA have been used to obtain a ball-park estimate of 400 for 2004 for WSA.<sup>2</sup>

### **Capture-recapture data**

The capture-recapture data available for these assessments are reported in Table A2.4 to Table A2.12 in Appendix 2.

#### Gabon capture-recapture data

These are the data that apply to the model-predicted number of whales found in the Gabon waters. They are available from the photographs and biopsies collected from the four field sites on the coast of Gabon (T. Collins, *pers. comm*). The reference case input data for these assessments are microsatellite data for males only from two sites (Iguela and Mayumba, see Table A2.4), while microsatellite data for both sexes and two sites (Table A2.5), fluke data from two sites (Table A2.8) and fluke data from all sites (Table A2.9) have been used in sensitivity runs.

#### WSA capture-recapture data

Recent capture-recapture analyses (Barendse *et al.*, 2010) have provided the data presented in Table A2.10 to Table A2.12. These data came from an electronic image database compiled for humpback whales photographed off the west coast of South Africa, and pertain to the model-predicted number of whales found in the WSA waters. The reference case input data are microsatellite data (Table A2.10), while right-dorsal fin (Table A2.11) and fluke data (Table A2.12) have been used in sensitivity runs.

#### Error rates

For these assessments, error rates of 0.0714 and 0.0780 (S. Cerchio, *pers. comm*) have been applied to the microsatellite capture-recapture data for Gabon and WSA respectively to account for false negative identifications. Similarly an error rate of 0.114 (J. Barendse, *pers. comm*) has been applied to the WSA right-dorsal fin data to correct for missed matches.

<sup>2</sup> The number of humpback whales found off WSA is estimated to be between 200 (using genetic microsatellite data) to 300 (using left-dorsal fin photographic data), but not exceeding 500 (J. Barendse, *pers. comm*). The ball-park estimate used here thus represents an upper limit for the numbers of humpbacks off WSA. This value should not, however, have a substantial effect on the assessment results, as its role is merely to reduce an otherwise very large uniform prior distribution in the interest of computational efficiency.

**$N_{min}$  constraints**

The minimum numbers of haplotypes recommended at the 62<sup>nd</sup> IWC SC meeting for the use in these assessments were 17 for Gabon and 6 for WSA. These values, however, correspond to the number of haplotypes unique to each area. As the models assume movement between WSA and Gabon, the total number of haplotypes for each region have been used instead (J. Jackson, *pers. comm*):

Gabon: 129 haplotypes

WSA: 71 haplotypes

Total number of unique haplotypes for Gabon and WSA: 136

These constraints are applied to the model-predicted number of whales found in the Gabon and WSA waters respectively, with more detail given in the Methods section.

**METHODS**

The different models explored in this assessment are briefly outlined here. Model diagrams and equations for the dynamics are given in Appendix 1.

*Reference case models*

**Model Ia** assumes two independent breeding sub-stocks (B1 and B2) which mix on Antarctic feeding grounds. Whales from breeding sub-stock B1 feed in the Antarctic and migrate to Gabon for breeding. Whales from breeding sub-stock B2 feed off WSA, and migrate along the West African coast through Gabon to a separate unidentified breeding ground. Additionally, some portion of B2 animals migrate to the Antarctic feeding grounds.

**Model IIa** assumes two breeding sub-stocks B1 and B2. B1 has two migratory components B1<sup>W</sup> and B1<sup>E</sup>. Whales from B1<sup>W</sup> migrate from the Antarctic feeding grounds directly to Gabon while whales from B1<sup>E</sup> migrate through the waters off WSA before continuing onto the Gabon breeding grounds. Whales from sub-stock B2 feed primarily off WSA and do not migrate past Gabon but instead to a separate unidentified breeding area. In addition, some portion of animals from sub-stock B2 migrates to Antarctic feeding grounds.

**Model IIIa** assumes a single breeding stock, B1, with two migratory components B1<sup>W</sup> and B1<sup>E</sup>. B1<sup>W</sup> migrates directly to Gabon from Antarctic feeding grounds, while B1<sup>E</sup> migrates through waters off WSA before continuing to the Gabon breeding grounds. In this assessment the proportion of animals using each migratory route does not change with time (other than as a result of the differential impact of catches).

*Lower priority models*

**Model Ib** is a variant of Model Ia in which there are two independent breeding sub-stocks that do not mix on the Antarctic feeding grounds. B1 feeds in the Antarctic and migrates to Gabon for breeding. B2 feeds off WSA and migrates along the West African coast through Gabon to a separate unidentified breeding area.

**Model Ic** is a variant of Model Ia in which breeding sub-stock B1 has two migratory components, B1<sup>W</sup> and B1<sup>E</sup>. B1<sup>W</sup> migrates directly to Gabon from the Antarctic feeding grounds. B1<sup>E</sup> migrates through the waters off WSA before reaching the Gabon breeding grounds.

**Model Id** is a variant of Model Ic in which some proportion of sub-stock B2 also migrates to Antarctic feeding grounds.

**Model Ie** is a variant of Model Ic in which some proportion of sub-stock B1 migrates through Gabon to a separate unidentified breeding area.

**Model IIb** is a variant of Model IIa which assumes two breeding stocks, B1 and B2. B1 is assumed to have two components, B1<sup>W</sup> and B1<sup>E</sup>. B1<sup>W</sup> migrates directly to Gabon from Antarctic feeding grounds while B1<sup>E</sup>

migrates through waters off WSA before continuing to the Gabon breeding grounds. B2 feeds off WSA, and does not migrate through the Gabon breeding ground but instead to a separate unidentified breeding area.

Model IV assumes two feeding sub-stocks, B1 and B2. B1 is assumed to have two migratory components, B1<sup>W</sup> and B1<sup>E</sup>. B1<sup>E</sup> passes through WSA waters before going to Gabon, while B1<sup>W</sup> migrates directly to Gabon breeding grounds from Antarctica. B2 feeds off WSA and migrates to Gabon breeding grounds.

#### *Model proposed intersessionally*

Model V allocates the Angolan catches (otherwise allocated 50% to Gabon and 50% to WSA for the reference case) to the catches off WSA. The model has stock B2 breeding off Angola, and splits this into two sub-stocks (B2<sup>W</sup> and B2<sup>E</sup>) where only the latter visits the area off WSA to which capture-recapture data relate. Some proportion of the B2<sup>E</sup> population migrates to the Antarctic.

For catch allocation purposes for regions where more than one stock/sub-stock of whales is present, complete mixing is assumed with catches each year allocated amongst the sub-stocks in proportion to their relative abundances.

#### *Sensitivity runs*

Table A1.11(a) and (b) list the assumptions used in the implementation of the reference case models above, as well as the assumptions for the various sensitivity runs performed.

### **Bayesian estimation framework**

#### *Priors*

Prior distributions are defined for the following parameters:

- i)  $r^i \sim U[0, 0.106]$
- ii)  $\ln \tilde{N}_{target}^{i,obs} \sim U[\ln N_{target}^{i,obs} - 4CV, \ln N_{target}^{i,obs} + 4CV]$

The target abundance estimates are fitted to the model-predicted number of whales found off Gabon and WSA respectively, i.e.  $i = \{Gabon, WSA\}$ .

The uninformative  $r$  prior is bounded by zero (negative rates of growth are biologically implausible) and 0.106 (this corresponds to the maximum growth rate for the species agreed by the IWC Scientific Committee (IWC, 2007)). The prior distribution from which target abundance estimate  $\tilde{N}_{target}^{i,obs}$  is drawn at random is uniform on a natural logarithmic scale. The lower and upper bounds are set by the CV multiplied by four. For these  $N$  targets, the Collins *et al.* (2008) estimate for 2003 of 7196 (CV=0.18) is used for Gabon, and the WSA capture-recapture data are used to provide a ball-park estimate for WSA (estimate for 2004 of 400, CV=0.2).

Using the randomly drawn vector of values of  $\tilde{N}_{target}^{i,obs}$  and  $r^i$ , a downhill simplex method of minimization is used to calculate  $K^i$  such that the model estimate of  $N_{target}^i$  is identical to the randomly drawn value  $\tilde{N}_{target}^{i,obs}$ .

For each simulation, using the  $r^i$  and calculated  $K^i$  values, the capture-recapture data are used to assign a likelihood to that particular combination. The components of the negative log likelihood are calculated as follows:

#### *Likelihood function*

The capture-recapture data give:

$n_y^i$ , the number of animals captured in region  $i$  in year  $y$ , where  $i = \{Gabon, WSA\}$ , and

$m_{y,y'}^i$ , the number of animals captured in year  $y$  in region  $i$  that were recaptured in year  $y'$  in region  $j$ .

If  $p_y^i$  is the probability that an animal is seen in region  $i$  in year  $y$ , then the number of animals captured in region  $i$  in year  $y$  is given by:

$$n_y^i = p_y^i N_y^i \quad (1)$$

where  $N_y^i$  is the total (1+) population. The model predicted number of animals captured in year  $y$  that were recaptured in year  $y'$  is given by:

$$\hat{m}_{y,y'}^i = p_y^i p_{y'}^i N_y^i e^{-M(y'-y)} \quad (2)$$

where:

$\hat{m}_{y,y'}^i$  is the model-predicted number of animals in  $i$  captured in year  $y$  that were recaptured in  $i$  in year  $y'$ , and

$M$  is the natural mortality rate (set here to equal  $0.03 \text{ yr}^{-1}$  as for the assessments of BSC (Johnston and Butterworth, *in prep.*)).

The contributions of these data to the negative of the log-likelihood function are then given by:

$$-\ln L = \sum_i \sum_{y=y_0}^{y_f-1} \sum_{y'=y+1}^{y_f} [-m_{y,y'}^i \ln \hat{m}_{y,y'}^i + \hat{m}_{y,y'}^i] \quad (3)$$

The negative log likelihood is then converted into a likelihood value ( $L$ ). The integration of the prior distributions of the parameters and the likelihood function then essentially follows the Sampling-Importance-Resampling (SIR) algorithm presented by Rubin (1988). For a vector of parameter values  $\theta_i$ , the likelihood of the data associated with this vector of parameters ( $L$ ) as described above is calculated and stored as  $\tilde{L}$ . This process is repeated until an initial sample of  $n_1$   $\theta_i$ s is generated.

This sample is then resampled with replacement  $n_2$  times with probability equal to weight  $w_j$ , where:

$$w_j = \frac{\tilde{L}(\theta_j / \text{data})}{\sum_{j=1}^{n_1} \tilde{L}(\theta_j / \text{data})} \quad (4)$$

The resample is thus a random sample of size  $n_2$  from the joint posterior distribution of the parameters (Rubin, 1988).

#### Error rates

The error rates for the microsatellite and right dorsal fin data are incorporated as follows. Suppose an error rate of  $q$  is assumed for false negatives, i.e. that if  $m_{y,y'}^i$  positive matches have been made in any particular year  $y'$ , this number corresponds to a proportion  $(1-q)$  of the actual number of correct matches. This is incorporated into the model by replacing  $\hat{m}_{y,y'}^i$  with  $(1-q)\hat{m}_{y,y'}^i$  in Equation (3) above<sup>3</sup>.

#### $N_{min}$ constraints

The reference case assumption for these assessments assumes that given a minimum number of haplotypes,  $h$ , for a specific region, the minimum population size for that region is given by  $4*h$  (Jackson *et al.*, 2006). This offers a constraint below which values the model estimated population trajectory must not go. A penalty thus needs to be added to the negative log likelihood to ensure that these constraints are not violated. To avoid a step-function

<sup>3</sup> Note that the factor of  $(1-q)$  was adjusted to  $(1-q)^2$  at IWC SC 63 to account for the fact that in addition to possible errors made in the recaptures, errors are also possible in the initial identification (i.e. errors in the value of  $n_y^i$  in Equation (1) above).

discontinuity, rather than taking the constraints as absolute cut-off values, the penalty added to the negative log-likelihood for  $N_{\min}^{\text{model}} < N_{\min}^{\text{genetics}}$  is:

$$\text{penalty} = \frac{(N_{\min}^{\text{model}} - N_{\min}^{\text{genetics}})^2}{2\sigma^2} \quad (5)$$

where  $N_{\min}^{\text{model}}$  is the minimum of the model predicted population trajectory and  $N_{\min}^{\text{genetics}}$  is the  $N_{\min}$  constraint arising from the observed minimum number of haplotypes. A value of  $\sigma = 0.0001N_{\min}^{\text{genetics}}$  was found to secure effective respect of the constraints.

## RESULTS

Table 1 lists results of the assessments of the various models and sensitivities. Given the large volume of results, only the median values for  $r$ ,  $K$  and  $N_{2010}/K$  along with their 90% probability intervals are given here. For models and sensitivities where both a B1 and B2 component are present, results are quoted for both these populations. For Model III and its sensitivities, where there is no B2 component, the results are given instead for B1<sup>W</sup> and B1<sup>E</sup>. For clarity sake, the results of Model Ia, IIa and III have been repeated in the table alongside their sensitivities/variants. Note that SEN 6 and 7, which deal with alternative  $N_{\min}$  constraints, have been compared to Case A of Model III, as Model III (Case A), SEN 6 and SEN 7 all apply individual  $N_{\min}$  constraints to Gabon and WSA.

Note that the  $X$  parameter has been estimated for Model III, rather than fixed on input. Since there is no B2 component, the WSA whales are solely from the B1 stock, and there needs to be more flexibility as to what proportion of the B1 whales move through the WSA grounds. The number of estimable parameters remains at two:  $K^{B1}$  and  $X$  (as opposed to  $K^{B1}$  and  $K^{B2}$  as was the case in Model Ia and IIa).

Two approaches regarding the implementation of the given  $N_{\min}$  constraints have been explored:

**Case A:** An  $N_{\min}$  constraint of  $4*129=516$  is applied to  $N^{\text{Gabon}}$ , and a constraint of  $4*71=284$  is applied to  $N^{\text{WSA}}$ .

**Case B:** An  $N_{\min}$  constraint of  $4*136=544$  is applied to  $N_y^{B1} + N_y^{B2}$  (or  $N_y^{B1,W} + N_y^{B1,E}$  in the case of Model III and its sensitivities).

These two methods were implemented for the reference case models (Model Ia, IIa and III) and the full set of results for both cases are reported in Table 2 to Table 4. The median population trajectories for these three models and two cases are shown in Figure 1 to Figure 3. For clarity sake the 90% probability envelopes have not been shown.

Figure 4 shows the post-model pre-data distribution for  $r^{B2}$  for Model Ia and IIa, and for  $r^{B1}$  for Model III. These plots indicate that prior incoherence is a much greater problem when the  $N_{\min}$  constraint is implemented as for Case A. As such, further models and sensitivities implement the  $N_{\min}$  constraint as for Case B.

Figure 5 (a) and (b) show the median trajectories for Model Ia, IIa, III, IV and Model V. Figure 5(a) shows the median trajectories for the B1 population (or the B1<sup>W</sup> population in the case of Model III), while Figure 5(b) shows the median trajectories for the B2 population (or B1<sup>E</sup> in the case of Model III). Again, the probability envelopes have not been shown here in the interest of clarity.

Figure 6 (a) and (b) show the whales available for sighting in Gabon and WSA for Model Ia, IIa, III, IV and Model V. These do not necessarily correspond to the entire B1/B2 populations, and are the numbers to which the capture-recapture data and  $N_{\min}$  constraints apply. The equations for these numbers have been given in the model descriptions in Appendix 1.

Figure 7 (a) and (b) show the B1 and B2 median trajectories for Model Ia and its variants Models Ib, Ic, Id and Ie.

Figure 8 (a) and (b) show the B1 and B2 median trajectories for Model IIa and its sensitivities (SEN 3a and b), which implement different values for the proportion of B2 whales that migrate down to the Antarctic. Note that

Model IIa has been used for these sensitivities since Model III (which has been used as the reference model for other sensitivities) does not have a B2 component.

Figure 9 (a) and (b) show the  $B1^W$  and  $B1^E$  median trajectories for Model III and four of its sensitivities: SEN 1a, SEN 1b, SEN 1c and SEN 5. These sensitivities implement alternative capture-recapture data to those used in the reference case models. Figure 10 (a)-(i) show the fits to the capture-recapture data for all the available data. In cases where a particular Gabon data set has been used in the fitting process for a particular model/sensitivity, this has been indicated in the legend with a star. Where WSA data have been used, this has been indicated with an open circle. Where there is no star or open circle indicated for a model/sensitivity, that particular data set has *not* been used in the fitting process. The model-predicted cumulative resightings are however still shown for comparison purposes.

Figure 11 (a) and (b) show the  $B1^W$  and  $B1^E$  median trajectories for Model III and the remaining four sensitivities: SEN 2b (which implements an alternative catch allocation hypothesis), SEN 4 (which tests a zero struck and loss rate), as well as SEN 6 and SEN 7 (which implement alternative values for the  $N_{min}$  constraints).

## DISCUSSION

### *General observations*

In general, the model predicted  $N_{2010}/K$  values are lower for  $B2/B1^E$  than for  $B1/B1^W$ . The estimates for B1 in Table 1 range from 0.508 [0.261, 0.833] to 0.750 [0.308, 1.000] for the main models. The estimates for B2 range from 0.045 [0.026, 0.075] to 0.124 [0.052, 0.870].

Note that the  $N_{2010}/K$  values given for Model III and its sensitivities can be misleading, as there is one total pristine population level that is estimated,  $K^{B1}$ , which is split into a  $B1^W$  and  $B1^E$  component using the estimated value for  $X$ . The growth of the individual sub-populations is limited by the total  $K^{B1}$  and as such it is possible for one of the two sub-populations to exceed their initial population level, provided the other population is at a low level. This is evident for the results of Model III and its sensitivities shown in Table 1, and seems to suggest that the WSA whales are more heavily depleted.

In the context of the above, it must be noted that the estimate  $r$  values are on the low side (when compared to other breeding stocks). For the main models, values for  $r^{B1}$  range from 0.039 to 0.052, while values for  $r^{B2}$  range from 0.043 to 0.069. Further,  $r^{B1}$  and even more so  $r^{B2}$  are in most cases poorly estimated, lying in the middle of a large probability envelope. While the problem of prior incoherence has largely been addressed by the application of a combined  $N_{min}$  constraint for  $N^{Gabon} + N^{WSA}$ , the extent to which this still affects the results would need to be more thoroughly investigated.

### *$N_{min}$ constraints*

Table 2 to Table 4 report the assessment results for Model Ia, IIa and III for the two different implementations of the  $N_{min}$  constraints. These, along with the post-model pre-data distributions shown in Figure 4, indicate that implementation of individual  $N_{min}$  constraints to the Gabon and WSA populations leads to low  $r$  values being favoured and suggests that the results are heavily influenced by prior incoherence. The alternative treatment, where a combined  $N_{min}$  constraint is applied to  $N^{Gabon} + N^{WSA}$ , leads to much more uninformative post-model, pre-data distributions, although the effect has clearly not been completely eradicated (see Model III in Figure 4).

SEN 6 and 7 test alternative values for the  $N_{min}$  constraints. It is important to note that the sensitivities apply the constraints individually to Gabon and WSA and are thus comparable to Case A of Model III, as shown in Table 1. The alternative constraints seem to improve the effect of the prior incoherence. SEN 7 indicates that it is indeed for the WSA region that prior incoherence becomes a problem, since the adjustment of only the WSA constraint leads to a much higher estimated  $r$  value than for Model III.

### *Comparison of the models*

Figure 5 (a) and (b) compare the B1 and B2 (or  $B1^W$  and  $B1^E$  in the case of Model III) trajectories for Model Ia, IIa, III, IV and V. In all cases the total numbers of  $B1+B2$  (or  $B1^W+B1^E$ ) in terms of pristine levels are reasonably

consistent, ranging between roughly 25000 and 29000. The biggest difference between the models seems to be in the proportion of this total pristine population that is estimated to belong to each sub-stock. Model IIa for example has a large B1 pristine component and a small B2 pristine component, while Model V predicts roughly equal numbers for each sub-stock at pristine conditions. Such differences will influence the estimated  $N_{2010}/K$  values for each sub-stock.

Figure 6 (a) and (b) show the trajectories of the number of whales available for sighting in Gabon and WSA. It is interesting to note that Model V estimates much smaller numbers in Gabon than the other models, presumably since Model V has a further B2<sup>w</sup> component which is not available for sighting in WSA (or Gabon) and thus not shown in these plots.

#### *Variants and sensitivities*

Figure 7 (a) and (b) show the median trajectories for Model Ia, Ib, Ic, Id and Ie. It is interesting to note that figure groups Model Ia and Ib together, as well as Model Ic and Id. Model Ia and Ib are virtually identical except for the assumed proportion of B2 whales that migrate down to the Antarctic. Similar can be said of Model Ic and Id. It therefore seems as though this migration of B2 to the Antarctic does not have a substantial effect on the assessment results. This observation seems to be supported by the results of SEN 3a and 3b in Figure 8, which show very little difference in the estimated trajectories when sensitivity to the proportion of B2 animals migrating to the Antarctic is tested.

Figure 9 (a) and (b) show the results of the sensitivities that use different capture-recapture data. It seems like the various capture-recapture data do not make a substantial impact on the population trajectory. Figure 10 shows the fits to the cumulative capture-recapture data. It is interesting to note that the fluke data is poorly fit for all the sensitivities for both Gabon and WSA.

Figure 11 shows Model III and the remaining four sensitivities. SEN 4 (struck and loss rate of 0) has a very similar trajectory to that of the reference case Model III, which is not unexpected since the struck and loss rate was only applied to pre-1914 catches. SEN 7, which uses 4x unique number of WSA haplotypes, also shows little difference to the Model III results, indicating that the use of this alternative  $N_{min}$  constraint for WSA yields similar results to applying a combined  $N_{min}$  constraint to  $N^{Gabon} + N^{WSA}$ . SEN 6 shows a substantially different trajectory to the reference case; however the very low estimated  $r$  values in Table 1 suggest that prior incoherence is the driving factor in these results.

## REFERENCES

- Barendse, J., Best, P.B., Thornton, M., Elwen, S.H., Pomilla, C., Carvalho, I. and Rosenbaum, H.C. 2010. Photo identification of humpback whales *Megaptera novaeangliae* off West South Africa (Breeding Stock B2) and a preliminary (sub-) population estimate. Paper SC/62/SH2 submitted to the IWC Scientific Committee, April 2010 (unpublished). 19pp.
- Collins, T., Cerchio, S., Pomilla, C., Loo, J., Carvalho, I., Ngoussono, S. and Rosenbaum, H.C. 2008. Revised estimates for humpback whale breeding stock B1: Gabon. Paper SC/60/SH28 submitted to the IWC Scientific Committee, April 2008 (unpublished). 17pp.
- Jackson, J., Zerbini, A., Clapham, P.J., Garrigue, C., Hauser, N., Poole, M., and Baker, C.S. 2006. A Bayesian assessment of humpback whales on breeding stocks of Eastern Australia and Oceania (IWC Stocks E, E1, E2 and F). Paper SC/A06/HW52 submitted to the IWC Workshop on the Comprehensive Assessment of Southern Hemisphere humpback whales, Hobart, Australia, April 2006 (unpublished). 19pp.
- Johnston S.J. and Butterworth, D.S. (in prep.). Bayesian Assessments (and simulation model testing) of Southern Hemisphere humpback whale breeding sub-stocks C1 and C3 using models which allow for interchange on the breeding grounds. 46pp.
- Rubin, D.B. 1988. Using the SIR algorithm to simulate posterior distributions. P. 395-402 in Bernardo, J.M., DeGroot, M.H., Lindley, D.V. and Smith, A.F.M. (ed.). 1988. Bayesian Statistics 3: Proceedings of the third Valencia International Meeting, June 1-5, 1987. Clarendon Press, Oxford. 805pp.



**Table 1:** Assessment results for the various models and sensitivity runs. In each case, the median values are given for the intrinsic growth rate  $r$ , pristine population level  $K$  and current (2010) abundance proportion of the pristine level. The 90% probability intervals are also given. For the purpose of this document, only results for the B1 and B2 populations are given here, where such a B2 component was present in the model. For Model III and its sensitivities, where there is no B2 component, results for the B1<sup>W</sup> and B1<sup>E</sup> populations have been given. These cases are highlighted in grey in the table below.

	B1 or B1,W				B2 or B1,E		
	$r$	$K$	$N_{2010}/K$		$r$	$K$	$N_{2010}/K$
Model Ia	0.048 [0.006,0.100]	15843 [ 10168., 32376.]	0.75 [0.308,1.000]	Model Ia	0.056 [0.007,0.103]	10908 [ 9521, 14548]	0.045 [0.026,0.075]
Model IIa	0.041 [0.008,0.086]	22969 [ 15673, 41056]	0.508 [0.261,0.833]	Model IIa	0.053 [0.005,0.101]	4270 [ 304, 7638]	0.121 [0.037,0.850]
Model III	0.052 [0.006,0.084]	10563 [ 6682, 30015]	1.162 [0.330,2.232]	Model III	0.052 [0.006,0.084]	14601 [ 13573, 15119]	0.031 [0.024,0.043]
Model IV	0.040 [0.009,0.086]	21612 [ 12442, 39624]	0.526 [0.239,0.927]	Model IV	0.057 [0.004,0.103]	4345 [ 481, 7404]	0.118 [0.046,0.773]
Model V	0.050 [0.004,0.100]	13593 [ 9292, 30011]	0.846 [0.334,1.000]	Model V	0.043 [0.006,0.077]	15442 [ 14633, 17834]	0.064 [0.038,0.108]
Model Ia	0.048 [0.006,0.100]	15843 [ 10168, 32376]	0.750 [0.308,1.000]	Model Ia	0.056 [0.007,0.103]	10908 [ 9521, 14548]	0.045 [0.026,0.075]
Model Ib	0.051 [0.004,0.097]	15458 [ 10496, 32233]	0.734 [0.316,0.999]	Model Ib	0.069 [0.009,0.103]	10695 [ 9453, 13222]	0.049 [0.028,0.078]
Model Ic	0.041 [0.009,0.077]	22079 [ 14938, 40152]	0.526 [0.244,0.835]	Model Ic	0.056 [0.007,0.101]	4361 [ 389, 6876]	0.124 [0.052,0.870]
Model Id	0.040 [0.009,0.082]	22176 [ 13572, 40096]	0.522 [0.243,0.894]	Model Id	0.055 [0.006,0.102]	4304 [ 389, 7856]	0.123 [0.035,0.734]
Model Ie	0.052 [0.011,0.096]	19011 [ 12247, 38322]	0.712 [0.296,0.998]	Model Ie	0.062 [0.007,0.102]	6558 [ 717, 10536]	0.082 [0.022,0.545]
Model IIa	0.041 [0.008,0.086]	22969 [ 15673, 41056]	0.508 [0.261,0.833]	Model IIa	0.053 [0.005,0.101]	4270 [ 304, 7638]	0.121 [0.037,0.850]
Model IIb	0.039 [0.007,0.075]	23412 [ 16998, 40989]	0.501 [0.235,0.785]	Model IIb	0.059 [0.006,0.102]	4082 [ 275, 6552]	0.133 [0.054,0.901]
SEN 3a	0.044 [0.008,0.085]	22139 [ 15495, 40895]	0.535 [0.251,0.848]	SEN 3a	0.050 [0.004,0.101]	4521 [ 362, 8389]	0.107 [0.018,0.801]
SEN 3b	0.039 [0.008,0.080]	23434 [ 16453, 41129]	0.504 [0.245,0.800]	SEN 3b	0.052 [0.004,0.101]	4223 [ 299, 6996]	0.119 [0.052,0.899]
Model III	0.052 [0.006,0.084]	10563 [ 6682, 30015]	1.162 [0.330,2.232]	Model III	0.052 [0.006,0.084]	14601 [ 13573, 15119]	0.031 [0.024,0.043]
SEN 1a	0.053 [0.009,0.077]	10313 [ 7229, 26182]	0.952 [0.314,1.663]	SEN 1a	0.053 [0.009,0.077]	14776 [ 13908, 15159]	0.032 [0.024,0.044]
SEN 1b	0.055 [0.011,0.073]	9883 [ 7642, 23318]	0.867 [0.309,1.401]	SEN 1b	0.055 [0.011,0.073]	14845 [ 14144, 15228]	0.027 [0.021,0.044]
SEN 1c	0.055 [0.014,0.073]	9565 [ 7339, 21188]	0.855 [0.331,1.397]	SEN 1c	0.055 [0.014,0.073]	15205 [ 14528, 15674]	0.047 [0.032,0.068]
SEN 2b	0.050 [0.006,0.083]	7394 [ 3968, 23903]	1.609 [0.418,3.678]	SEN 2b	0.050 [0.006,0.083]	18162 [ 17850, 18706]	0.025 [0.019,0.035]
SEB 4	0.052 [0.007,0.083]	10159 [ 6471, 27750]	1.153 [0.362,2.181]	SEB 4	0.052 [0.007,0.083]	12623 [ 11865, 13044]	0.035 [0.027,0.051]
SEN 5	0.058 [0.019,0.077]	9438 [ 7215, 19673]	1.015 [0.392,1.664]	SEN 5	0.058 [0.019,0.077]	14851 [ 14155, 15173]	0.027 [0.021,0.044]
Model III (Case A)	0.006 [0.001,0.014]	29605 [ 23264, 35755]	0.334 [0.258,0.472]	Model III (Case A)	0.006 [0.001,0.014]	13643 [ 13184, 14202]	0.028 [0.023,0.039]
SEN 6	0.024 [0.004,0.047]	18138 [ 11425, 32631]	0.583 [0.298,1.098]	SEN 6	0.024 [0.004,0.047]	14012 [ 13404, 14635]	0.030 [0.024,0.043]
SEN 7	0.048 [0.006,0.077]	11331 [ 7285, 29425]	1.053 [0.318,1.966]	SEN 7	0.048 [0.006,0.077]	14520 [ 13523, 15128]	0.031 [0.024,0.044]

**Table 2 (a):** Full assessment results for Model Ia for the **Case A**, where an  $N_{min}$  constraint of  $4*129$  is applied to  $N^{B1}$  and  $4*71$  is applied to  $N^{B2}$ , where 129 and 71 are the total number of haplotypes unique to Gabon and WSA respectively. Median values 90% probability envelopes in parenthesis are given. The assumptions made are also given.

	<b>B1</b>		<b>B2</b>	
<b>Capture recapture data</b>	<b>Microsatellite, males only, two sites</b> (applied to $N_y^{B1} + p_2 N_y^{B2}$ )		<b>Microsatellites</b> (applied to $N_y^{B2}$ )	
$N_{min}$ constraint	<b>4*129=516</b>		<b>4*71=284</b>	
<b>Catch allocation (north of 40S)</b>	<b>Congo and 50% Angola</b>		<b>50% Angola, Namibia, WSA</b>	
<b>Proportion of B2 that migrates to the Antarctic</b>	<b>0.5</b>		<b>0.5</b>	
<b>Struck and lost rate</b>	<b>0.15</b>		<b>0.15</b>	
$r$	0.045	[0.005,0.098]	0.008	[0.001,0.025]
$K$	15070	[ 7267, 27461]	13958	[ 10000, 21325]
$N_{min}$	2309	[ 438,17075]	366	[ 284, 674]
$N_{min}$ (Gabon)	2517	[ 622,17384]		
$N_{min}$ (WSA)	366	[ 284, 674]		
$N_{min}$ (Total: B1+B2)	2750	[ 807,17671]		
$N_{2010}$	8590	[ 4309, 14414]	603	[ 317, 942]
$N_{min}/K$	0.14	[0.048,0.683]	0.026	[0.017,0.058]
$N_{2010}/K$	0.603	[0.202,1.000]	0.040	[0.020,0.080]
$N_{2040}/K$	0.963	[0.282,1.000]	0.051	[0.022,0.159]

**Table 2(b):** Full assessment results for Model Ia for **Case B**, where an  $N_{min}$  constraint of  $4*136$  is applied to  $N^{B1}+N^{B2}$ , where 136 is the total number of unique haplotypes for B1+B2. Median values 90% probability envelopes in parenthesis are given. The assumptions made are also given.

	<b>B1</b>		<b>B2</b>	
<b>Capture recapture data</b>	<b>Microsatellite, males only, two sites</b> (applied to $N_y^{B1} + p_2 N_y^{B2}$ )		<b>Microsatellites</b> (applied to $N_y^{B2}$ )	
$N_{min}$ constraint	<b>4*136=544 applied to <math>N^{B1} + N^{B2}</math></b>		<b>4*136=544 applied to <math>N^{B1} + N^{B2}</math></b>	
<b>Catch allocation (north of 40S)</b>	<b>Congo and 50% Angola</b>		<b>50% Angola, Namibia, WSA</b>	
<b>Proportion of B2 that migrates to the Antarctic</b>	<b>0.5</b>		<b>0.5</b>	
<b>Struck and lost rate</b>	<b>0.15</b>		<b>0.15</b>	
$r$	0.048	[0.006,0.100]	0.056	[0.007,0.103]
$K$	15843	[ 10168, 32376]	10908	[ 9521, 14548]
$N_{min}$	2494	[ 651, 8389]	49	[ 10, 284]
$N_{min}$ (Gabon)	2555	[ 704, 8416]		
$N_{min}$ (WSA)	49	[ 10, 284]		
$N_{min}$ (Total: B1+B2)	2580	[ 732, 8427]		
$N_{2010}$	10929	[ 8790, 13120]	497	[ 342, 755]
$N_{min}/K$	0.155	[0.059,0.346]	0.009	[0.001,0.023]
$N_{2010}/K$	0.750	[0.308,1.000]	0.004	[0.001,0.021]
$N_{2040}/K$	0.989	[0.374,1.000]	0.241	[0.036,0.850]

**Table 3 (a):** Full assessment results for Model IIa for **Case A**, where an  $N_{min}$  constraint of  $4*129$  is applied to  $N^{Gabon}$  and  $4*71$  is applied to  $N^{WSA}$ , where 129 and 71 are the total number of haplotypes unique to Gabon and WSA respectively. Median values 90% probability envelopes in parenthesis are given. The assumptions made are also given. The results shown here are for an  $X = 0.7$ .

Assumption	Gabon	WSA
<b>Capture recapture data</b>	Microsatellite, males only, two sites (applied to $N_y^{B1} + N_y^{B2}$ )	Microsatellites (applied to $N_y^{B2} + N_y^{B1,E}$ )
<b>Catch allocation (north of 40S)</b>	Congo and 50% Angola (applied to $N_y^{B1} + N_y^{B2}$ )	50% Angola, Namibia, WSA (applied to $N_y^{B2} + N_y^{B1,E}$ )
<b><math>N_{min}</math> constraint</b>	$4*129=516$	$4*71=284$
<b>Proportion of B2 that migrates to the Antarctic</b>	0.5	0.5
<b>Struck and lost rate</b>	0.15	0.15

	<b>B1</b>		<b>B2</b>		<b>B1,W</b>		<b>B1,E</b>	
$r$	0.008	[0.002,0.072]	0.014	[0.001,0.096]	$r^{B1}$		$r^{B1}$	
$K$	40976	[ 16850, 46503]	550	[ 10, 7761]	28683	[ 11795, 32552]	12293	[ 5055, 13951]
$N_{2010}$	10681	[ 8294, 13453]	180	[ 9, 429]	10403	[ 8037, 13230]	249	[ 122, 469]
$N_{min}$	7165	[ 863, 9503]	79	[ 3, 279]	7004	[ 847, 9199]	160	[ 14, 419]
$N_{min}$ (Gabon/WSA whales)	7165	[ 863, 9503]	284	[ 284, 434]				
$N_{min}$ (Total: B1+B2)	7307	[ 1147, 9519]						
$N_{min}/K$	0.082	[0.033,0.126]	0.058	[0.036,0.318]	0.377	[0.257,1.039]	0.025	[0.013,0.044]
$N_{2010}/K$	0.173	[0.048,0.215]	0.116	[0.035,0.346]	0.239	[0.068,0.298]	0.014	[0.003,0.030]
$N_{2040}/K$	0.338	[0.201,0.998]	0.265	[0.043,1.000]	0.473	[0.276,1.402]	0.032	[0.016,0.062]

**Table 3 (b):** Full assessment results for Model IIa for **Case B**, where an  $N_{min}$  constraint of  $4*136$  is applied to  $N^{B1}+N^{B2}$ , where 136 is the total number of unique haplotypes for B1+B2. Median values 90% probability envelopes in parenthesis are given. The assumptions made are also given. The results shown here are for an  $X = 0.7$ .

Assumption	Gabon	WSA
<b>Capture recapture data</b>	Microsatellite, males only, two sites (applied to $N_y^{B1} + N_y^{B2}$ )	Microsatellites (applied to $N_y^{B2} + N_y^{B1,E}$ )
<b>Catch allocation (north of 40S)</b>	Congo and 50% Angola (applied to $N_y^{B1} + N_y^{B2}$ )	50% Angola, Namibia, WSA (applied to $N_y^{B2} + N_y^{B1,E}$ )
<b><math>N_{min}</math> constraint</b>	$4*136=544$ applied to $N^{B1} + N^{B2}$	$4*136=544$ applied to $N^{B1} + N^{B2}$
<b>Proportion of B2 that migrates to the Antarctic</b>	0.5	0.5
<b>Struck and lost rate</b>	0.15	0.15

	<b>B1</b>		<b>B2</b>		<b>B1,W</b>		<b>B1,E</b>	
<i>R</i>	0.041	[0.008,0.086]	0.053	[0.005,0.101]	$r^{B1}$		$r^{B1}$	
<i>K</i>	22969	[ 15673, 41056]	4270	[ 304, 7638]	16078	[ 10971, 28739]	6891	[ 4702, 12317]
<i>N<sub>2010</sub></i>	11783	[ 9348, 14626]	458	[ 175, 733]	11721	[ 9310, 14595]	3	[ 0, 247]
<i>N<sub>min</sub></i>	2481	[ 557, 7665]	53	[ 10, 227]	2478	[ 556, 7557]	1	[ 0, 141]
<i>N<sub>min</sub> (Gabon/WSA whales)</i>	2481	[ 557, 7665]	67	[ 11, 284]				
<i>N<sub>min</sub> (Total: B1+B2)</i>	2553	[ 748, 7818]						
<i>N<sub>min</sub>/K</i>	0.173	[0.048,0.215]	0.116	[0.035,0.346]	0.239	[0.068,0.298]	0.014	[0.003,0.030]
<i>N<sub>2010</sub>/K</i>	0.508	[0.261,0.833]	0.121	[0.037,0.850]	0.724	[0.366,1.183]	0.000	[0.000,0.031]
<i>N<sub>2040</sub>/K</i>	0.338	[0.201,0.998]	0.265	[0.043,1.000]	0.473	[0.276,1.402]	0.032	[0.016,0.062]

**Table 4 (a):** Full assessment results for Model IIIa for **Case A**, where an  $N_{min}$  constraint of  $4*129$  is applied to  $N^{Gabon}$  and  $4*71$  is applied to  $N^{WSA}$ , where 129 and 71 are the total number of haplotypes unique to Gabon and WSA respectively. Median values 90% probability envelopes in parenthesis are given. The assumptions made are also given.

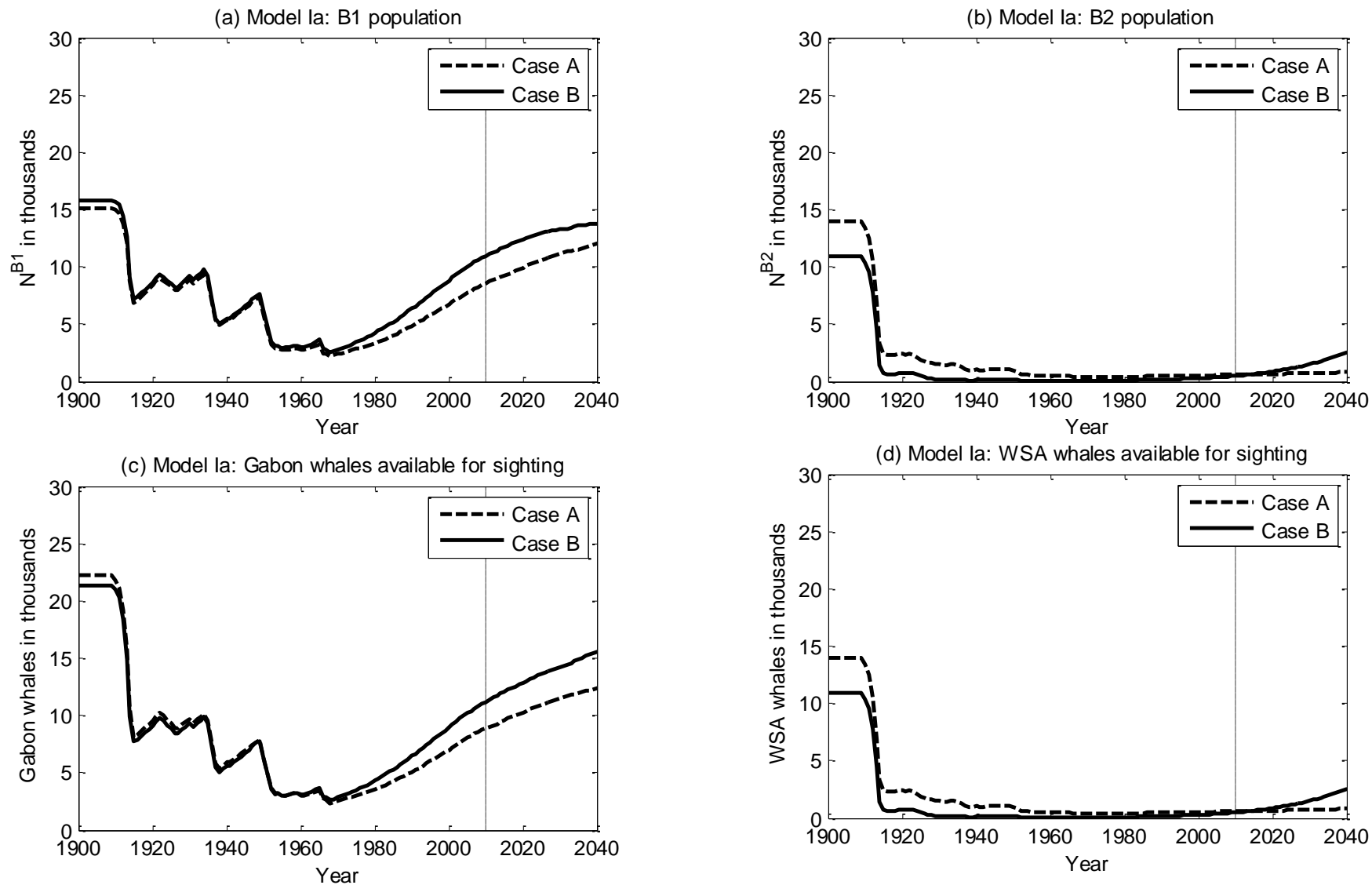
Assumption	Gabon	WSA
<b>Capture recapture data</b>	Microsatellite, males only, two sites (applied to $N_y^{B1,W} + N_y^{B1,E}$ )	Microsatellites (applied to $N_y^{B1,E}$ )
<b>Catch allocation (north of 40S)</b>	Congo and 50% Angola (applied to $N_y^{B1,W} + N_y^{B1,E}$ )	50% Angola, Namibia, WSA (applied to $N_y^{B1,E}$ )
$N_{min}$ constraint	$4*129=516$	$4*71=284$
<b>Proportion of B2 that migrates to the Antarctic</b>	NA	NA
<b>Struck and lost rate</b>	0.15	0.15

	<b>BI</b>		<b>BI,W</b>		<b>BI,E</b>	
$r$	0.006	[0.001,0.014]	$r^{BI}$		$r^{BI}$	
$K$	43281	[ 37268, 49277]	29605	[ 23264, 35755]	13643	[ 13184, 14202]
$X$	0.685	[0.623,0.729]				
$N_{2010}$	10346	[ 8406, 13049]	9944	[ 7973, 12691]	387	[ 304, 547]
$N_{min}$	8010	[ 5766,10868]	7716	[ 5449,10523]	284	[ 284, 417]
$N_{min}$ (Gabon whales)	8010	[ 5766,10868]				
$N_{min}$ (WSA whales)	284	[ 284, 417]				
$N_{min}/K$	0.185	[0.150,0.227]	0.26	[0.219,0.310]	0.021	[0.020,0.030]
$N_{2010}/K$	0.238	[0.188,0.314]	0.334	[0.258,0.472]	0.028	[0.023,0.039]
$N_{2040}/K$	0.281	[0.202,0.437]	0.393	[0.273,0.671]	0.034	[0.024,0.055]

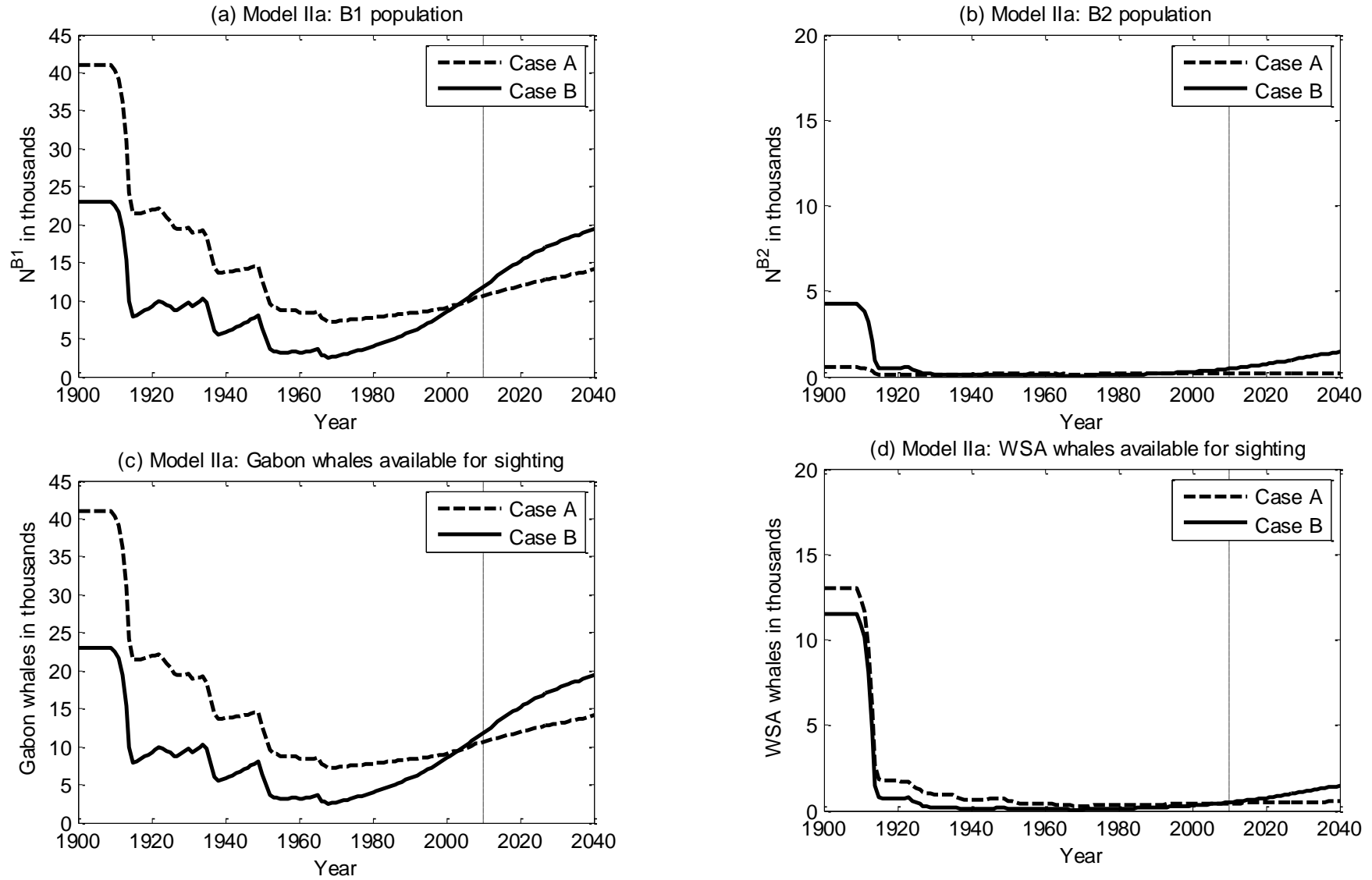
**Table 4 (b):** Full assessment results for Model IIIa for **Case B**, where an  $N_{min}$  constraint of  $4*136$  is applied to  $N^{BI,W}+N^{BI,E}$ , where 136 is the total number of unique haplotypes for Gabon+WSA. Median values 90% probability envelopes in parenthesis are given. The assumptions made are also given.

Assumption	Gabon	WSA
<b>Capture recapture data</b>	Microsatellite, males only, two sites (applied to $N_y^{BI,W} + N_y^{BI,E}$ )	Microsatellites (applied to $N_y^{BI,E}$ )
<b>Catch allocation (north of 40S)</b>	Congo and 50% Angola (applied to $N_y^{BI,W} + N_y^{BI,E}$ )	50% Angola, Namibia, WSA (applied to $N_y^{BI,E}$ )
<b><math>N_{min}</math> constraint</b>	$4*136=544$ applied to $N^{BI}$	$4*136=544$ applied to $N^{BI}$
<b>Proportion of B2 that migrates to the Antarctic</b>	NA	NA
<b>Struck and lost rate</b>	0.15	0.15

	<b>BI</b>		<b>BI,W</b>		<b>BI,E</b>	
$r$	0.052	[0.006,0.084]	$r^{BI}$		$r^{BI}$	
$K$	25202	[ 21783, 43560]	10563	[ 6682, 30015]	14601	[ 13573, 15119]
$X$	0.419	[0.307,0.689]				
$N_{2010}$	12704	[ 9413, 16105]	12248	[ 8983, 15613]	452	[ 336, 647]
$N_{min}$	1668	[ 594, 8333]	1597	[ 569, 8058]	60	[ 20, 284]
$N_{min}$ (Gabon whales)	1668	[ 594, 8333]				
$N_{min}$ (WSA whales)	60	[ 20, 284]				
$N_{min}/K$	0.066	[0.027,0.192]	0.15	[0.085,0.276]	0.004	[0.001,0.021]
$N_{2010}/K$	0.502	[0.233,0.718]	1.162	[0.330,2.232]	0.031	[0.024,0.043]
$N_{2040}/K$	0.966	[0.276,0.999]	2.201	[0.392,3.139]	0.053	[0.033,0.081]

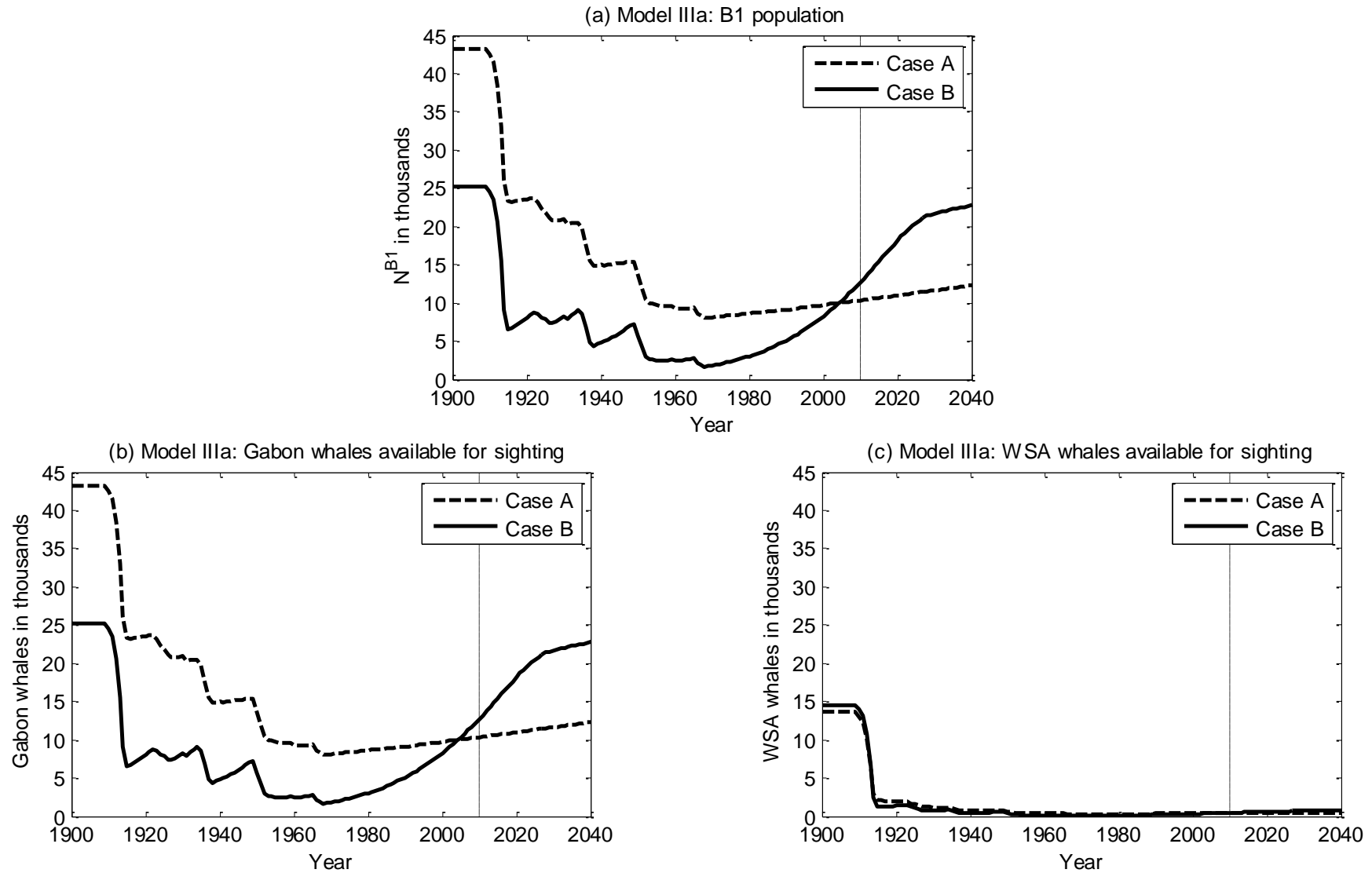


**Figure 1 (a)-(d):** Median population trajectories for Model Ia for Case A and Case B. The trajectories and their 90% probability envelopes are shown. Values to the right of the dashed line are projections into the future under zero catch. Figures (c) and (d) show trajectories for  $N_y^{B1} + p_2 N_y^{B2}$  and  $N_y^{B2}$  respectively.

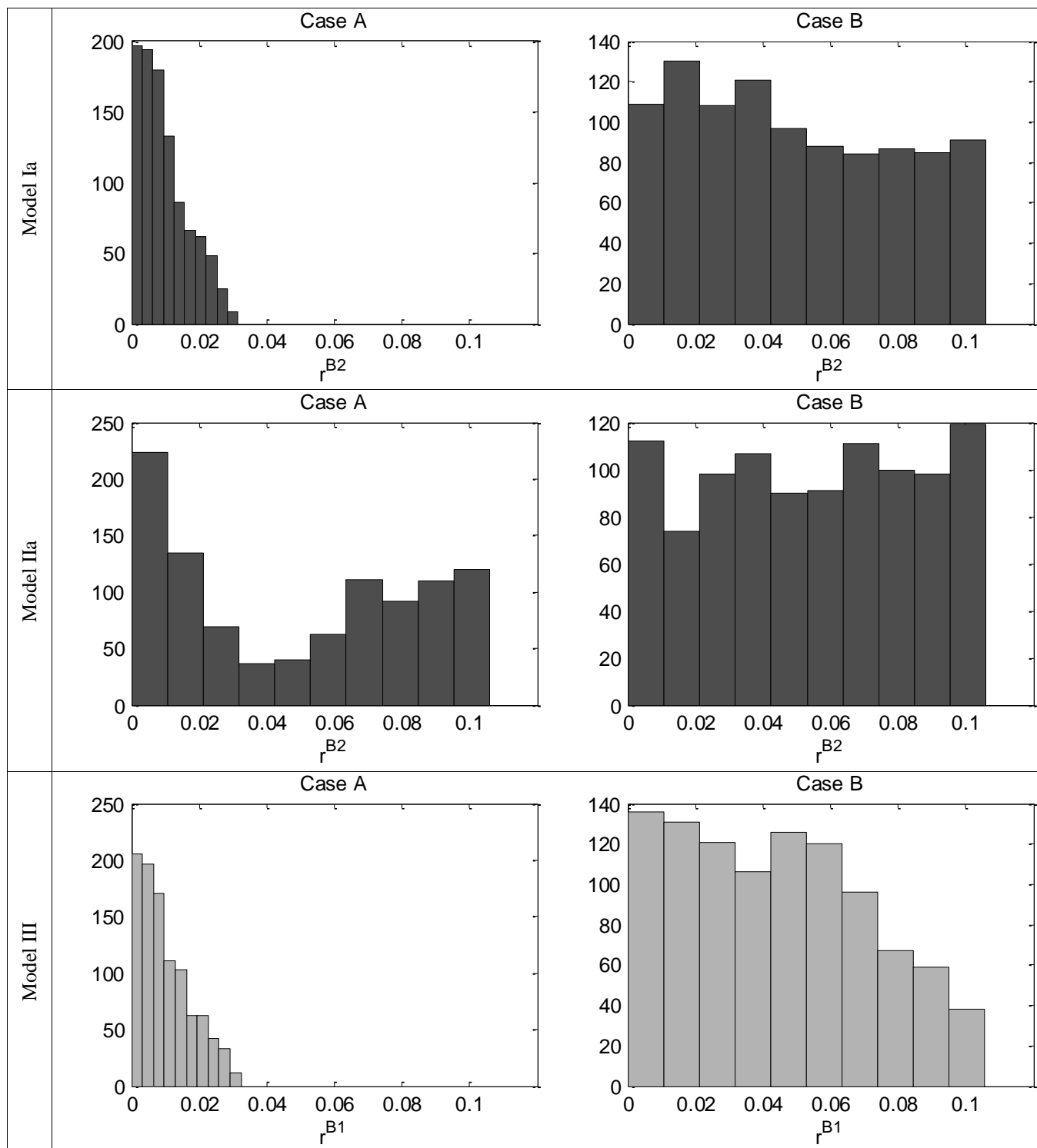


**Figure 2 (a)-(d):** Median population trajectories for Model IIa for Case A and Case B. The trajectories and their 90% probability envelopes are shown. Values to the right of the dashed line are projections into the future under zero catch. Figures (c) and (d) show trajectories for  $N_y^{B1}$  and  $N_y^{B2} + N_y^{B1,E}$  respectively.

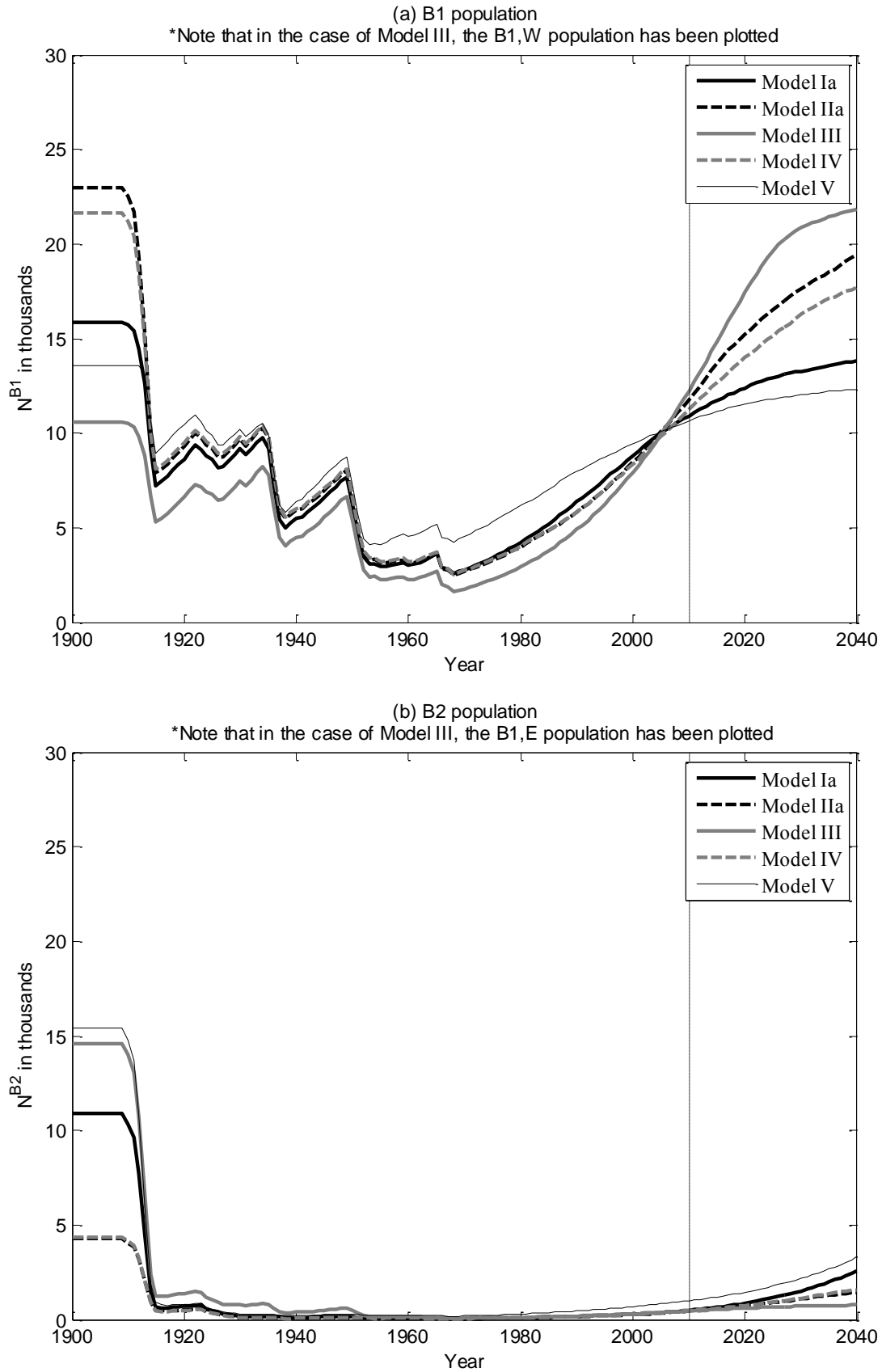




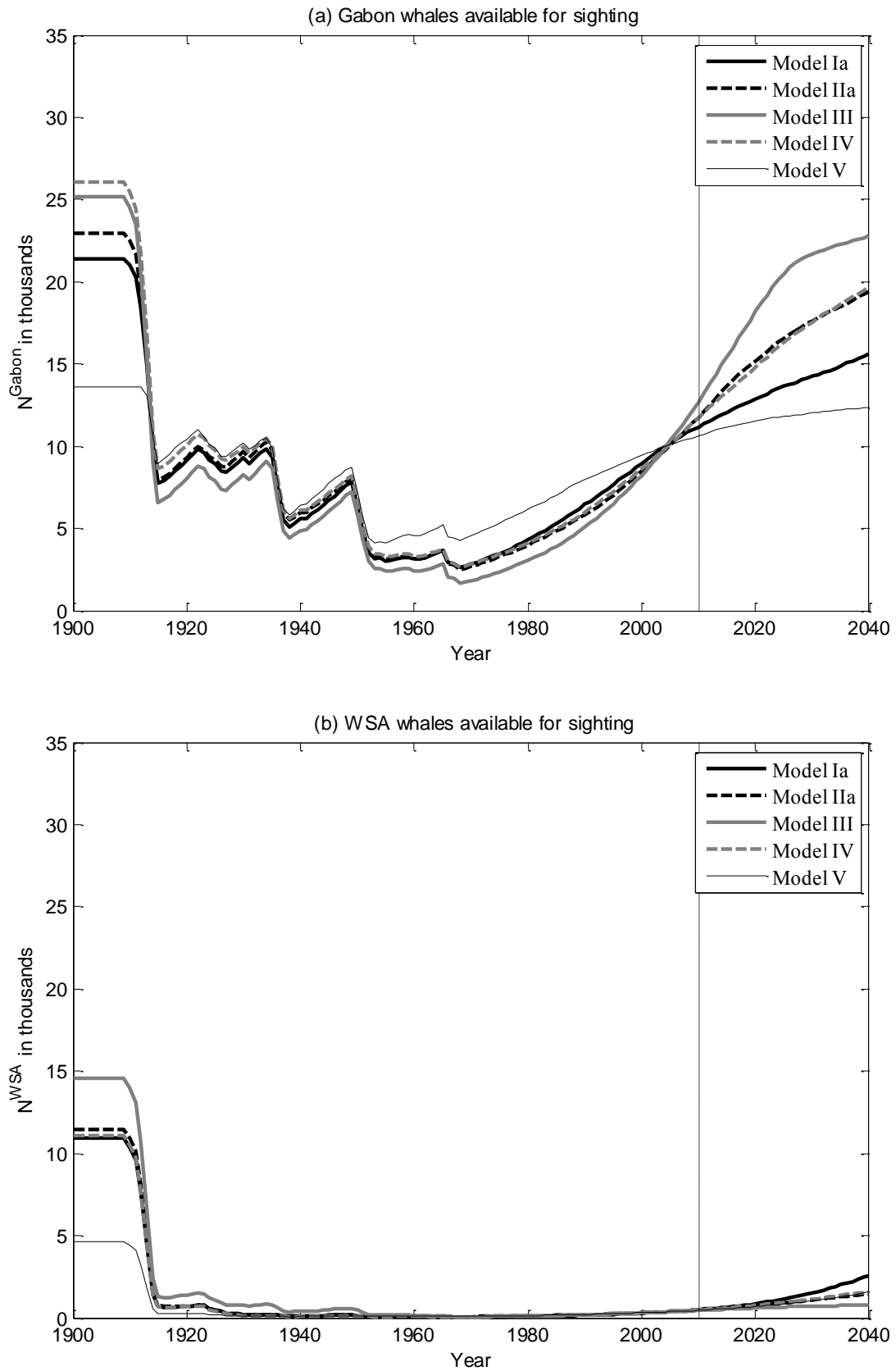
**Figure 3 (a)-(d):** Median population trajectories for Model IIIa for Case A and Case B. The trajectories and their 90% probability envelopes are shown. Values to the right of the dashed line are projections into the future under zero catch. Figures (c) and (d) show trajectories for  $N_y^{B1}$  and  $N_y^{B2} + N_y^{B1,E}$  respectively.



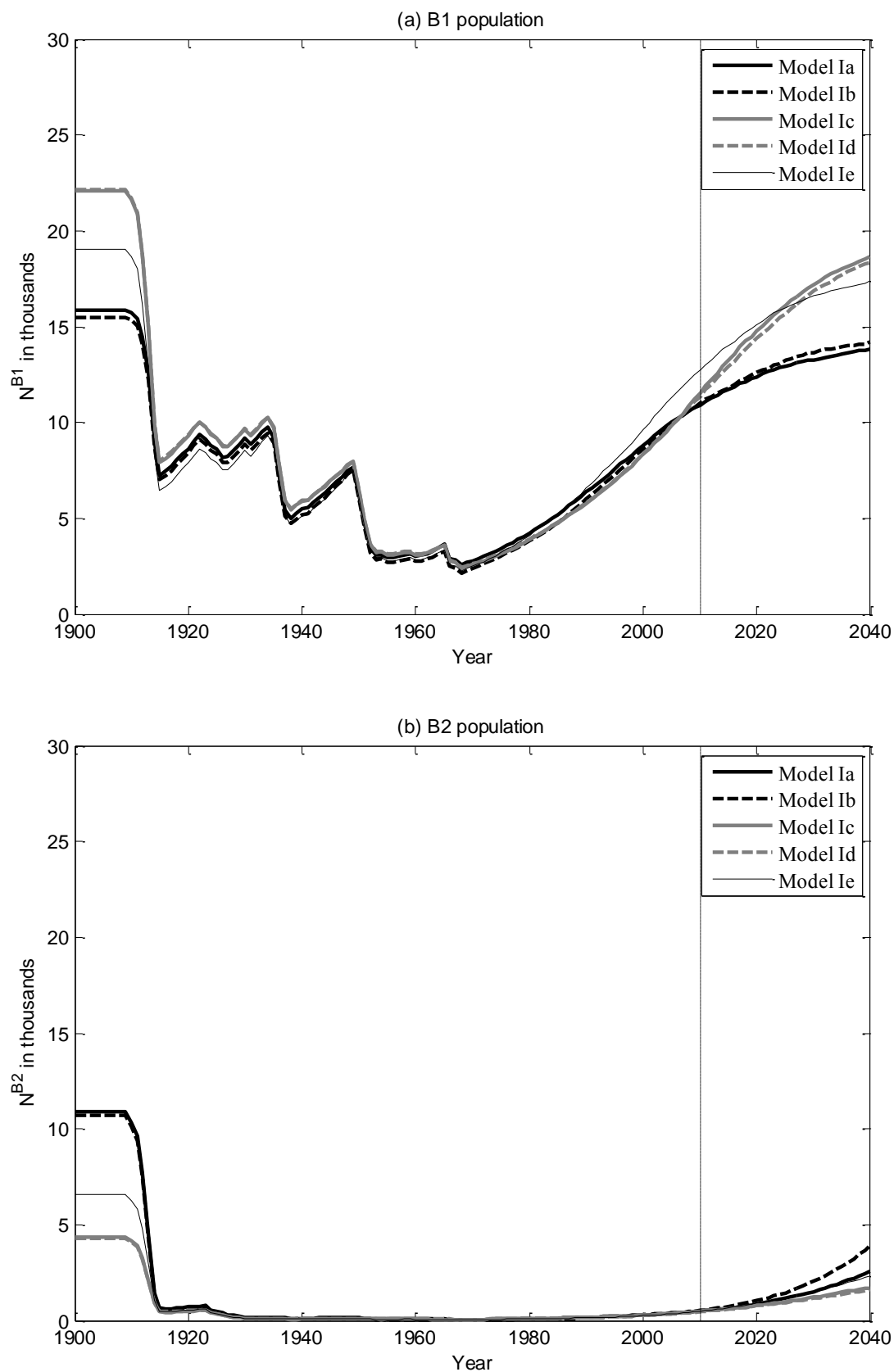
**Figure 4:** Post-model, pre-data distributions for  $r$ . These distributions are derived by implementing the SIR resampling approach with only the  $N_{min}$  penalty in the (penalised) log-likelihood and show the parameter values that adhere to the  $N_{min}$  constraints. The distributions are shown for Model Ia, Model IIa and Model III for Case A and Case B. For Model Ia and IIa, the results for  $r^{B2}$  are shown, as this is where the problem of prior incoherence is most prevalent. For Model III, where there is no  $B2$  component, the results for  $r^{B1}$  have been shown.



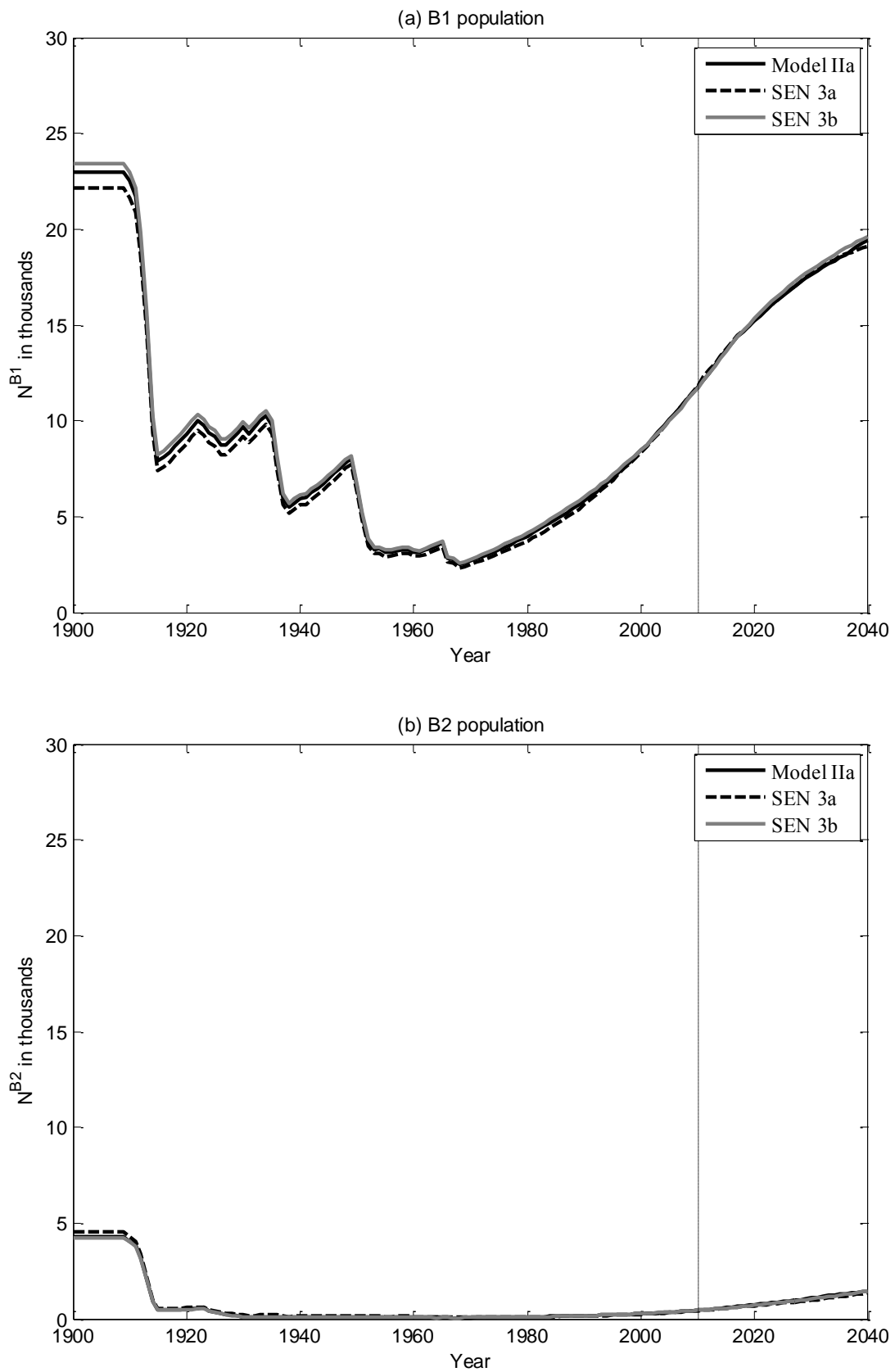
**Figure 5 (a)-(b):** Median population trajectories for Model Ia-Model V. For the sake of clarity, the 90% confidence intervals have not been shown here. Trajectories to the right of the vertical dashed line show projections into the future under the assumption of zero catch.



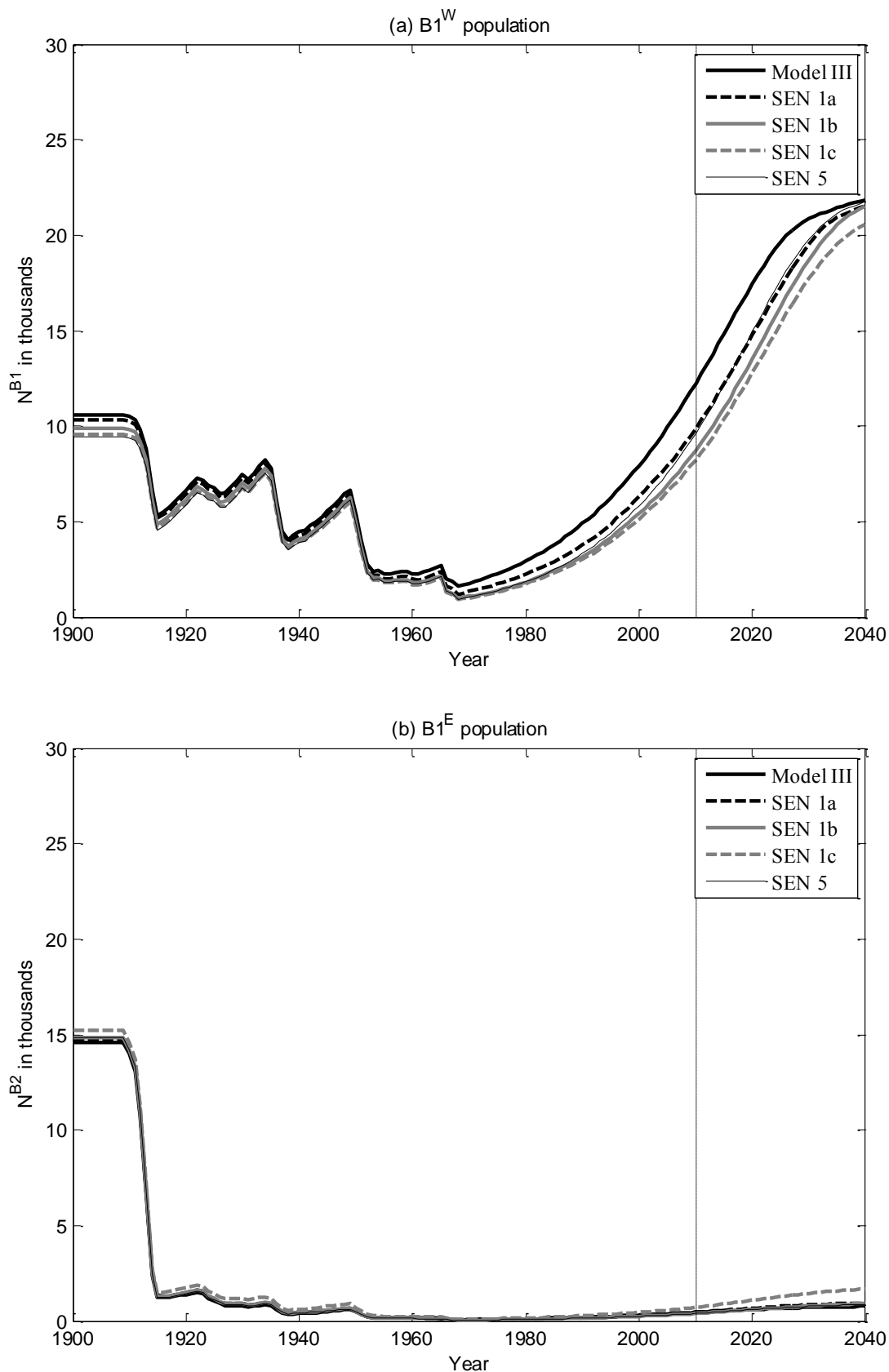
**Figure 6 (a)-(b):** Median population trajectories for Model Ia-Model V, showing the whales available for sighting in Gabon and WSA. These are the population numbers to which the capture-recapture data and  $N_{min}$  constraints pertain. Trajectories to the right of the vertical dashed line show projections into the future under the assumption of zero catch.



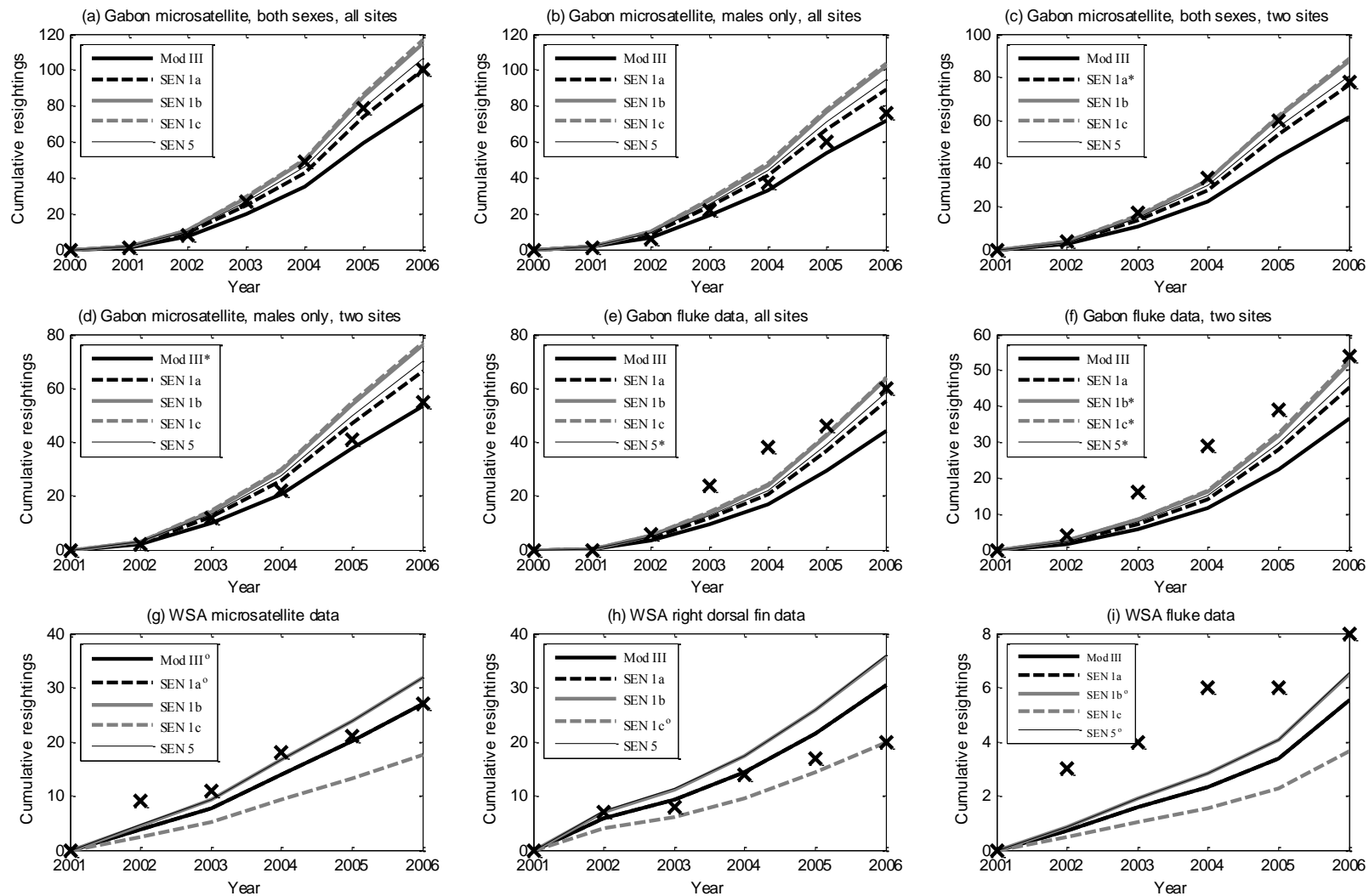
**Figure 7 (a)-(b):** Median population trajectories for Model Ia-Model Ie. For the sake of clarity, the 90% confidence intervals have not been shown here. Trajectories to the right of the vertical dashed line show projections into the future under the assumption of zero catch.



**Figure 8 (a)-(b):** Model IIA and its two sensitivities. Model IIA assumes that 50% of the B2 animals migrate to the Antarctic, while SEN 3a and b assumes that 100% and 0% respectively of these animals migrate to the Antarctic. The median trajectories are shown, and trajectories to the right of the vertical dashed line show projections into the future under the assumption of zero catch.

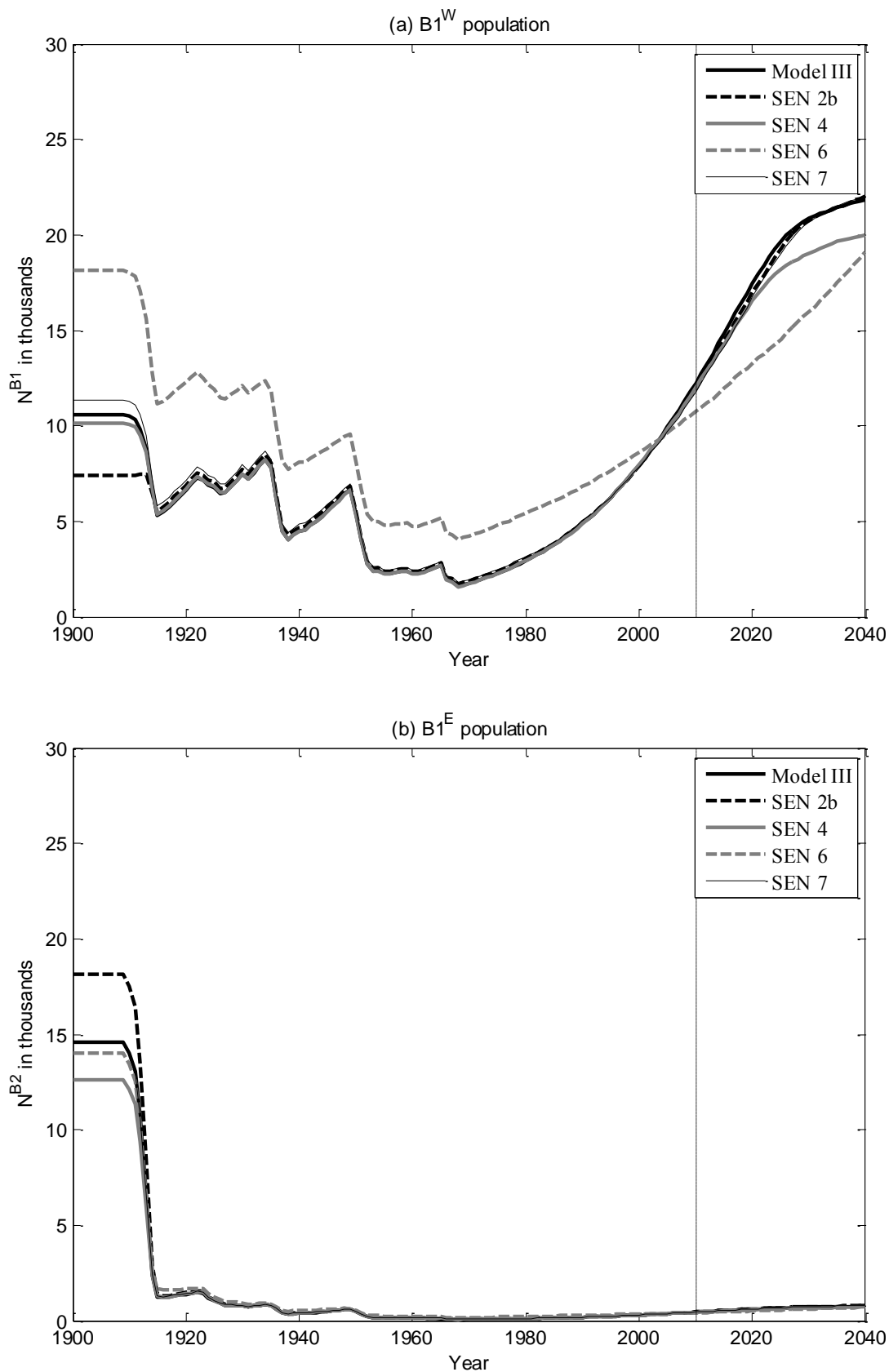


**Figure 9 (a)-(b):** Model III and four of its sensitivities. Note that since there is no B2 component, the results have been shown for the  $B1^W$  and  $B1^E$  populations. Model III uses microsatellites from two sites and males only for Gabon, and microsatellites for WSA. SEN 1a uses microsatellites from two sites, but both sexes for Gabon and microsatellites for WSA. SEN 1b uses flukes from two sites for Gabon, and flukes for WSA. SEN 1c uses flukes from two sites for Gabon and right dorsal fin data for WSA.



**Figure 10:** The observed cumulative resightings (marked by X's) compared to those predicted in median terms by Model III and some of its sensitivities. Where Gabon data have been used in the fitting process for a particular model/sensitivity, this has been indicated in the legend with a star. Where WSA data have been used, this has been indicated with an open circle.





**Figure 11 (a)-(b):** Model III and the last four of its sensitivities. SEN 2b tests the alternative catch allocation hypothesis. SEN 4 tests a struck and loss rate of 0. SEN 6 implements  $N_{min}$  constraints of  $1 \times \#haplotypes + 1$ . SEN 7 uses the number of unique haplotypes for B2, rather than the total number.

Appendix 1

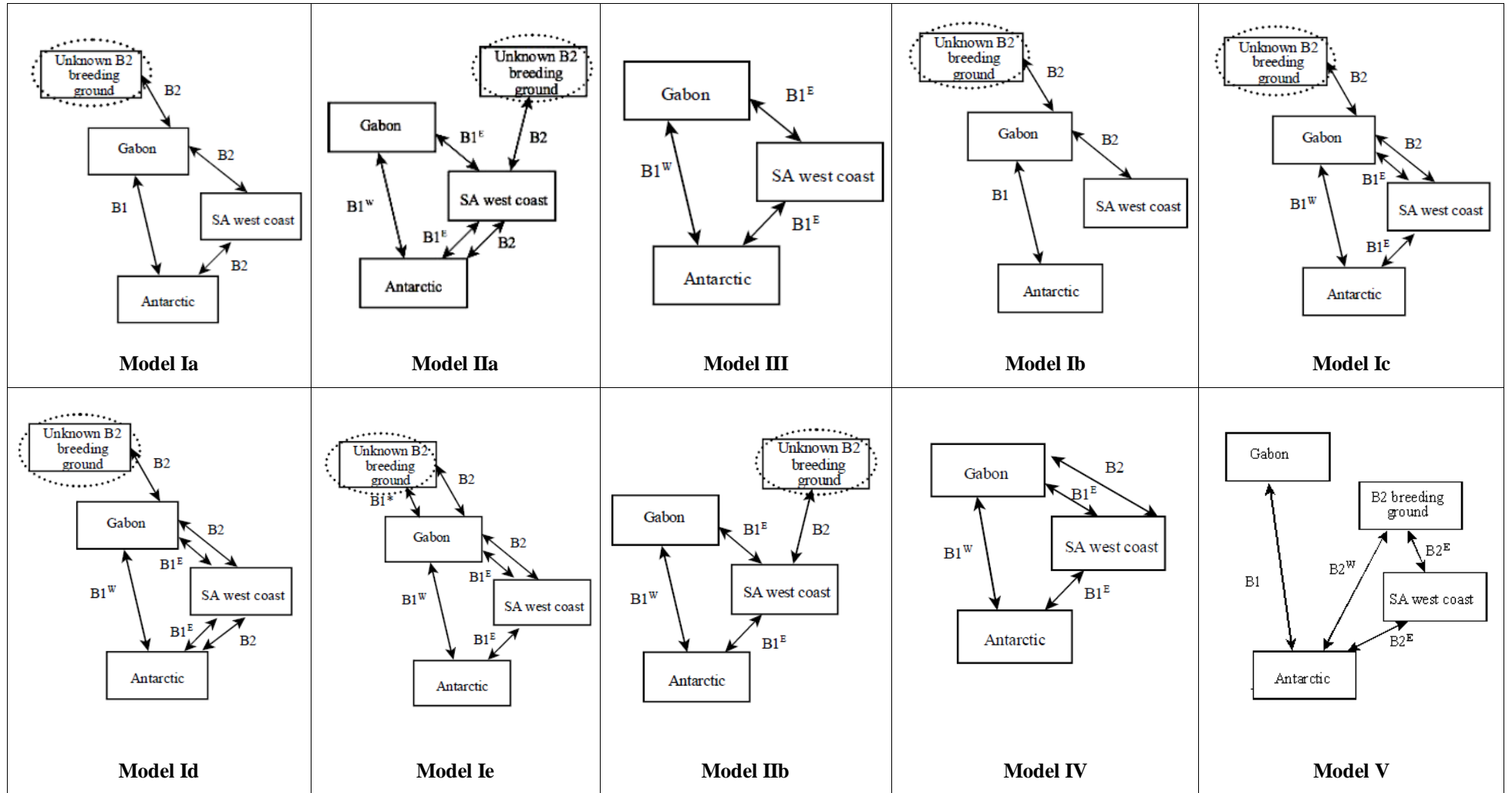
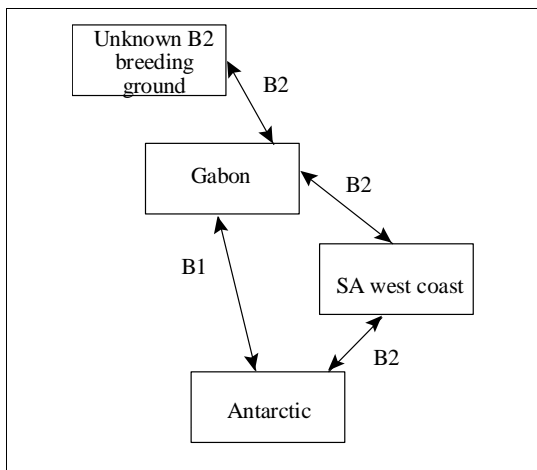


Figure A1.1: Diagrammatic representation of the 10 proposed models.

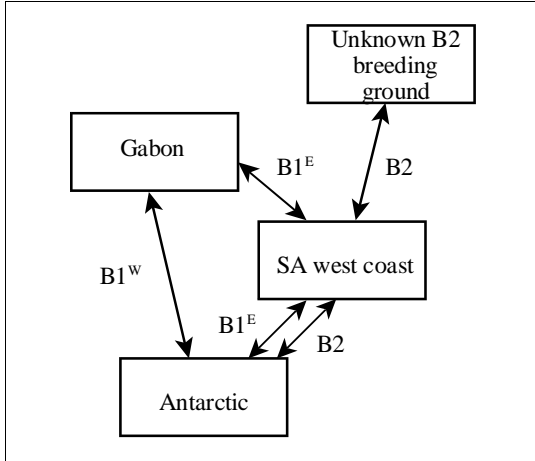
**Model Ia***Model description:*

Model Ia assumes two independent breeding sub-stocks which can mix on Antarctic feeding grounds. Whales from breeding sub-stock B1 feed in the Antarctic and migrate to Gabon for breeding. Whales from breeding sub-stock B2 feed off WSA and migrate along the West African coast through Gabon to a separate unidentified breeding ground. Additionally, some portion of B2 animals migrate to the Antarctic feeding grounds.

**Table A1.1:** Breeding stock dynamics and catch equations for Model Ia. Equations for the numbers of whales off Gabon/WSA are also given. These are the groups to which the capture-recapture data and  $N_{min}$  constraints apply.

<i>Breeding stock population dynamics:</i>	$N_{y+1}^{B1} = N_y^{B1} + r^{B1} N_y^{B1} \left[ 1 - \left[ \frac{N_y^{B1}}{K^{B1}} \right]^\mu \right] - C_y^{B1} \quad (A1.1)$
	$N_{y+1}^{B2} = N_y^{B2} + r^{B2} N_y^{B2} \left[ 1 - \left[ \frac{N_y^{B2}}{K^{B2}} \right]^\mu \right] - C_y^{B2} \quad (A1.2)$
<i>Catches:</i>	$C_y^{B1} = p_y^{A,B1} C_y^A + p_y^{G,B1} C_y^G \quad (A1.3)$
	$C_y^{B2} = p_y^{A,B2} C_y^A + C_y^{WSA} + p_y^{G,B2} C_y^G \quad (A1.4)$ <p>where</p> $p_y^{A,B1} = \frac{N_y^{B1}}{N_y^{B1} + p_1 N_y^{B2}} \text{ and } p_y^{A,B2} = \frac{p_1 N_y^{B2}}{N_y^{B1} + p_1 N_y^{B2}}$ $p_y^{G,B1} = \frac{N_y^{B1}}{N_y^{B1} + p_2 N_y^{B2}} \text{ and } p_y^{G,B2} = \frac{p_2 N_y^{B2}}{N_y^{B1} + p_2 N_y^{B2}}$ <p>and <math>p_1</math> is the proportion of B2 animals that migrate to the Antarctic. <math>p_2</math> is the probability of sighting (or catching) a B2 animal as it transits through the Gabon breeding area relative to the probability for a B1 animal in that area.</p>
<i>Gabon/WSA numbers</i>	<p>Gabon: <math>N_y^{B1} + p_2 N_y^{B2}</math></p> <p>WSA: <math>N_y^{B2}</math>.</p>

### Model IIa



#### Model description

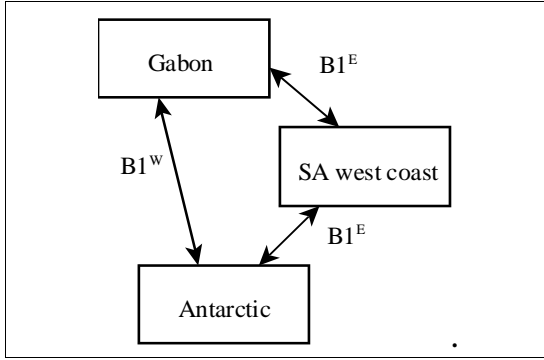
Model IIa assumes two breeding sub-stocks B1 and B2. B1 has two migratory components B1<sup>W</sup> and B1<sup>E</sup>. Whales from B1<sup>W</sup> migrate from the Antarctic feeding grounds directly to Gabon while whales from B1<sup>E</sup> migrate through the waters off WSA before continuing onto the Gabon breeding grounds. Whales from sub-stock B2 feed primarily off WSA and do not migrate past Gabon but instead to a separate unidentified breeding area. In addition, some portion of animals from sub-stock B2 migrates to Antarctic feeding grounds. Given the carrying capacity for B1, the carrying capacities for its sub-stocks are given by:

$$K^{BS1,W} = XK^{BS1} \quad \text{and} \quad K^{BS1,E} = (1-X)K^{BS1}$$

**Table A1.2:** Breeding stock dynamics and catch equations for Model IIa. Equations for the numbers of whales off Gabon/WSA are also given. These are the groups to which the capture-recapture data and  $N_{min}$  constraints apply.

<i>Breeding stock population dynamics:</i>	$N_{y+1}^{B1,W} = N_y^{B1,W} + r^{B1} N_y^{B1,W} \left[ 1 - \left[ \frac{N_y^{B1,W} + N_y^{B1,E}}{K^{B1}} \right]^\mu \right] - C_y^{B1,W} \quad (\text{A1.5})$
	$N_{y+1}^{B1,E} = N_y^{B1,E} + r^{B1} N_y^{B1,E} \left[ 1 - \left[ \frac{N_y^{B1,W} + N_y^{B1,E}}{K^{B1}} \right]^\mu \right] - C_y^{B1,E} \quad (\text{A1.6})$
	$N_{y+1}^{B2} = N_y^{B2} + r^{B2} N_y^{B2} \left[ 1 - \left[ \frac{N_y^{B2}}{K^{B2}} \right]^\mu \right] - C_y^{B2} \quad (\text{A1.7})$
<i>Catches:</i>	$C_y^{B1,W} = p_y^{A,B1,W} C_y^A + p_y^{G,B1,W} C_y^G \quad (\text{A1.8})$
	$C_y^{B1,E} = p_y^{A,B1,E} C_y^A + p_y^{WSA,B1,E} C_y^{WSA} + p_y^{G,B1,E} C_y^G \quad (\text{A1.9})$
	$C_y^{B2} = p_y^{A,B2} C_y^A + p_y^{WSA,B2} C_y^{WSA} \quad (\text{A1.10})$
	<p>where</p> $p_y^{A,B1,W} = \frac{N_y^{B1,W}}{N_y^{B1,W} + N_y^{B1,E} + p_1 N_y^{B2}}$ $p_y^{A,B1,E} = \frac{N_y^{B1,E}}{N_y^{B1,W} + N_y^{B1,E} + p_1 N_y^{B2}}$ $p_y^{A,B2} = \frac{p_1 N_y^{B2}}{N_y^{B1,W} + N_y^{B1,E} + p_1 N_y^{B2}}$ $p_y^{G,B1,W} = \frac{N_y^{B1,W}}{N_y^{B1,W} + N_y^{B1,E}} \quad \text{and} \quad p_y^{G,B1,E} = \frac{N_y^{B1,E}}{N_y^{B1,W} + N_y^{B1,E}}$ $p_y^{WSA,B1,E} = \frac{N_y^{B1,E}}{N_y^{B1,E} + N_y^{B2}} \quad \text{and} \quad p_y^{WSA,B2} = \frac{N_y^{B2}}{N_y^{B1,E} + N_y^{B2}}$ <p>and <math>p_1</math> is the proportion of B2 animals that migrate to the Antarctic.</p>
<i>Gabon/WSA numbers</i>	<p>Gabon: <math>N_y^{B1,W} + N_y^{B1,E}</math>          WSA: <math>N_y^{B2} + N_y^{B1,E}</math>.</p>

**Model III**



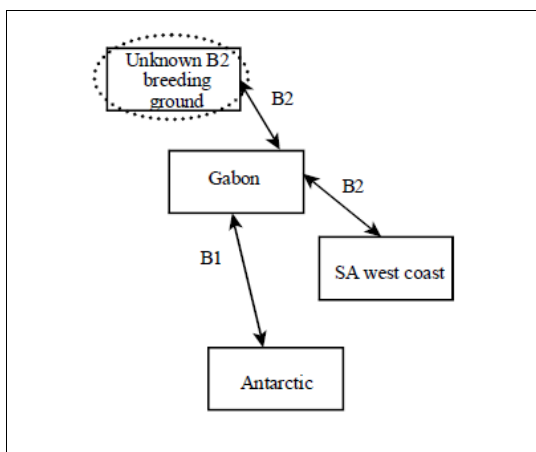
*Model description*

Model III assumes a single breeding stock, B1, with two migratory components B1<sup>W</sup> and B1<sup>E</sup>. B1<sup>W</sup> migrates directly to Gabon from Antarctic feeding grounds, while B1<sup>E</sup> migrates through waters off WSA before continuing on to the Gabon breeding grounds. In this assessment the proportion of animals using each migratory route does not change with time (other than as a result of the differential impact of catches). Given the carrying capacity for B1, the carrying capacities for its sub-stocks are given by:

$$K^{BS1,W} = XK^{BS1} \quad \text{and} \quad K^{BS1,E} = (1 - X)K^{BS1}$$

**Table A1.3:** Breeding stock dynamics and catch equations for Model III. Equations for the numbers of whales off Gabon/WSA are also given. These are the groups to which the capture-recapture data and  $N_{min}$  constraints apply.

<i>Breeding stock population dynamics:</i>	$N_{y+1}^{B1,W} = N_y^{B1,W} + r^{B1} N_y^{B1,W} \left[ 1 - \left[ \frac{N_y^{B1,W} + N_y^{B1,E}}{K^{B1}} \right]^\mu \right] - C_y^{B1,W} \quad (A1.11)$
	$N_{y+1}^{B1,E} = N_y^{B1,E} + r^{B1} N_y^{B1,E} \left[ 1 - \left[ \frac{N_y^{B1,W} + N_y^{B1,E}}{K^{B1}} \right]^\mu \right] - C_y^{B1,E} \quad (A1.12)$
<i>Catches:</i>	$C_y^{B1,W} = p_y^{A,B1,W} C_y^A + p_y^{G,B1,W} C_y^G \quad (A1.13)$ $C_y^{B1,E} = p_y^{A,B1,E} C_y^A + C_y^{WSA} + p_y^{G,B1,E} C_y^G \quad (A1.14)$ <p>where</p> $p_y^{A,B1,W} = \frac{N_y^{B1,W}}{N_y^{B1,W} + N_y^{B1,E}} \quad \text{and} \quad p_y^{A,B1,E} = \frac{N_y^{B1,E}}{N_y^{B1,W} + N_y^{B1,E}}$ $p_y^{G,B1,W} = \frac{N_y^{B1,W}}{N_y^{B1,W} + N_y^{B1,E}} \quad \text{and} \quad p_y^{G,B1,E} = \frac{N_y^{B1,E}}{N_y^{B1,W} + N_y^{B1,E}}$
<i>Gabon/WSA numbers:</i>	<p>Gabon: <math>N_y^{B1,W} + N_y^{B1,E}</math></p> <p>WSA: <math>N_y^{B1,E}</math></p>

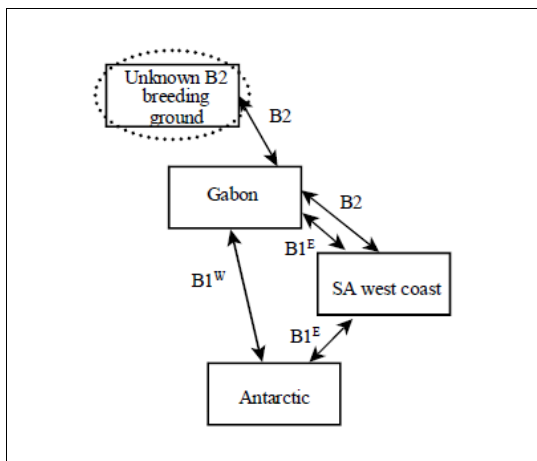
**Model Ib***Model description:*

Model Ib is a variant of Model I in which there are two independent breeding sub-stocks that do not mix on the Antarctic feeding grounds. B1 feeds in the Antarctic and migrates to Gabon for breeding. B2 feeds off WSA and migrates along the West African coast through Gabon to a separate unidentified breeding area.

**Table A1.4:** Breeding stock dynamics and catch equations for Model Ib. Equations for the numbers of whales off Gabon/WSA are also given. These are the groups to which the capture-recapture data and  $N_{min}$  constraints apply.

<i>Breeding stock population dynamics:</i>	$N_{y+1}^{B1} = N_y^{B1} + r^{B1} N_y^{B1} \left[ 1 - \left[ \frac{N_y^{B1}}{K^{B1}} \right]^\mu \right] - C_y^{B1} \quad (\text{A1.15})$ $N_{y+1}^{B2} = N_y^{B2} + r^{B2} N_y^{B2} \left[ 1 - \left[ \frac{N_y^{B2}}{K^{B2}} \right]^\mu \right] - C_y^{B2} \quad (\text{A1.16})$
<i>Catches:</i>	$C_y^{B1} = C_y^A + p_y^{G,B1} C_y^G \quad (\text{A1.17})$ $C_y^{B2} = C_y^{WSA} + p_y^{G,B2} C_y^G \quad (\text{A1.18})$ <p>where</p> $p_y^{G,B1} = \frac{N_y^{B1}}{N_y^{B1} + p_2 N_y^{B2}} \text{ and } p_y^{G,B2} = \frac{p_2 N_y^{B2}}{N_y^{B1} + p_2 N_y^{B2}}$ <p>and <math>p_2</math> is the probability of sighting (or catching) a B2 animal as it transits through the Gabon breeding area relative to the probability for a B1 animal in that area.</p>
<i>Gabon/WSA numbers</i>	<p>Gabon: <math>N_y^{B1} + p_2 N_y^{B2}</math></p> <p>WSA: <math>N_y^{B2}</math>.</p>

## Model Ic



## Model description

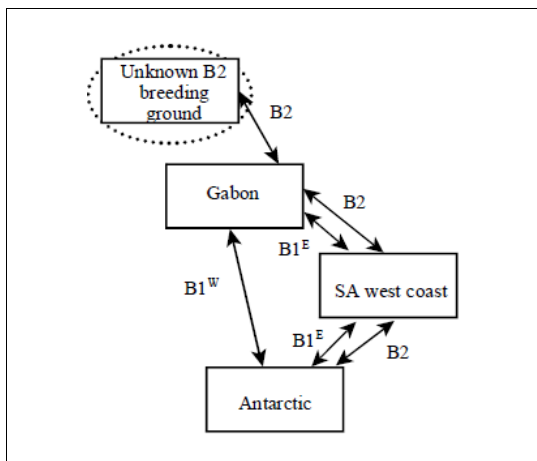
Model Ic is a variant of Model I in which breeding sub-stock B1 has two migratory components,  $B1^W$  and  $B1^E$ .  $B1^W$  migrates directly to Gabon from the Antarctic feeding grounds.  $B1^E$  migrates through the waters off west South Africa before reaching the Gabon breeding grounds. Given the carrying capacity for B1, the carrying capacities for its sub-stocks are given by:

$$K^{BS1,W} = XK^{BS1} \quad \text{and} \quad K^{BS1,E} = (1-X)K^{BS1}$$

**Table A1.5:** Breeding stock dynamics and catch equations for Model Ic. Equations for the numbers of whales off Gabon/WSA are also given. These are the groups to which the capture-recapture data and  $N_{min}$  constraints apply.

Breeding stock population dynamics:	$N_{y+1}^{B1,W} = N_y^{B1,W} + r^{B1} N_y^{B1,W} \left[ 1 - \left[ \frac{N_y^{B1,W} + N_y^{B1,E}}{K^{B1}} \right]^\mu \right] - C_y^{B1,W} \quad (\text{A1.19})$
	$N_{y+1}^{B1,E} = N_y^{B1,E} + r^{B1} N_y^{B1,E} \left[ 1 - \left[ \frac{N_y^{B1,W} + N_y^{B1,E}}{K^{B1}} \right]^\mu \right] - C_y^{B1,E} \quad (\text{A1.20})$
	$N_{y+1}^{B2} = N_y^{B2} + r^{B2} N_y^{B2} \left[ 1 - \left[ \frac{N_y^{B2}}{K^{B2}} \right]^\mu \right] - C_y^{B2} \quad (\text{A1.21})$
Catches:	$C_y^{B1,W} = p_y^{A,B1,W} C_y^A + p_y^{G,B1,W} C_y^G \quad (\text{A1.22})$
	$C_y^{B1,E} = p_y^{A,B1,E} C_y^A + p_y^{WSA,B1,E} C_y^{WSA} + p_y^{G,B1,E} C_y^G \quad (\text{A1.23})$
	$C_y^{B2} = p_y^{WSA,B2} C_y^{WSA} + p_y^{G,B2} C_y^G \quad (\text{A1.24})$
	<p>where</p> $p_y^{A,B1,W} = \frac{N_y^{B1,W}}{N_y^{B1,W} + N_y^{B1,E}} \quad \text{and} \quad p_y^{A,B1,E} = \frac{N_y^{B1,E}}{N_y^{B1,W} + N_y^{B1,E}}$ $p_y^{G,B1,W} = \frac{N_y^{B1,W}}{N_y^{B1} + p_2 N_y^{B2}} \quad \text{and} \quad p_y^{G,B1,E} = \frac{N_y^{B1,E}}{N_y^{B1} + p_2 N_y^{B2}}$ $p_y^{G,B2} = \frac{p_2 N_y^{B2}}{N_y^{B1} + p_2 N_y^{B2}}$ $p_y^{WSA,B1,E} = \frac{N_y^{B1,E}}{N_y^{B1,E} + N_y^{B2}} \quad \text{and} \quad p_y^{WSA,B2} = \frac{N_y^{B2}}{N_y^{B1,E} + N_y^{B2}}$ <p>and <math>p_2</math> is the probability of sighting (or catching) a B2 animal as it transits through the Gabon breeding area relative to the probability for a B1 animal in that area.</p>
Gabon/WSA numbers	<p>Gabon: <math>N_y^{B1} + p_2 N_y^{B2}</math></p> <p>WSA: <math>N_y^{B2} + N_y^{B1,E}</math></p>

### Model Id



#### Model description

Model Id is a variant of Model Ic in which some proportion of sub-stock B2 also migrates to Antarctic feeding grounds. Given the carrying capacity for B1, the carrying capacities for its sub-stocks are given by:

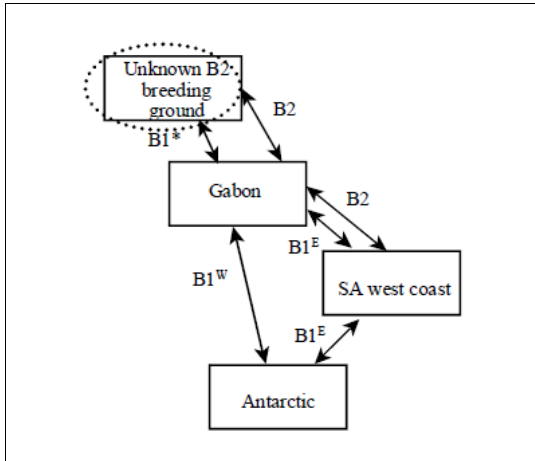
$$K^{BS1,W} = XK^{BS1} \quad \text{and} \quad K^{BS1,E} = (1-X)K^{BS1}$$

**Table A1.6:** Breeding stock dynamics and catch equations for Model Id. Equations for the numbers of whales off Gabon/WSA are also given. These are the groups to which the capture-recapture data and  $N_{min}$  constraints apply.

Breeding stock population dynamics:	$N_{y+1}^{B1,W} = N_y^{B1,W} + r^{B1} N_y^{B1,W} \left[ 1 - \left[ \frac{N_y^{B1,W} + N_y^{B1,E}}{K^{B1}} \right]^\mu \right] - C_y^{B1,W} \quad (\text{A1.25})$
	$N_{y+1}^{B1,E} = N_y^{B1,E} + r^{B1} N_y^{B1,E} \left[ 1 - \left[ \frac{N_y^{B1,W} + N_y^{B1,E}}{K^{B1}} \right]^\mu \right] - C_y^{B1,E} \quad (\text{A1.26})$
	$N_{y+1}^{B2} = N_y^{B2} + r^{B2} N_y^{B2} \left[ 1 - \left[ \frac{N_y^{B2}}{K^{B2}} \right]^\mu \right] - C_y^{B2} \quad (\text{A1.27})$
Catches:	$C_y^{B1,W} = p_y^{A,B1,W} C_y^A + p_y^{G,B1,W} C_y^G \quad (\text{A1.28})$
	$C_y^{B1,E} = p_y^{A,B1,E} C_y^A + p_y^{WSA,B1,E} C_y^{WSA} + p_y^{G,B1,E} C_y^G \quad (\text{A1.29})$
	$C_y^{B2} = p_y^{A,B2} C_y^A + p_y^{WSA,B2} C_y^{WSA} + p_y^{G,B2} C_y^G \quad (\text{A1.30})$
	<p>where</p> $p_y^{A,B1,W} = \frac{N_y^{B1,W}}{N_y^{B1} + p_1 N_y^{B2}} \quad \text{and} \quad p_y^{A,B1,E} = \frac{N_y^{B1,E}}{N_y^{B1} + p_1 N_y^{B2}}$ $p_y^{A,B2} = \frac{p_1 N_y^{B2}}{N_y^{B1} + p_1 N_y^{B2}} \quad \text{and} \quad p_y^{G,B2} = \frac{p_2 N_y^{B2}}{N_y^{B1} + p_2 N_y^{B2}}$ $p_y^{G,B1,W} = \frac{N_y^{B1,W}}{N_y^{B1} + p_2 N_y^{B2}} \quad \text{and} \quad p_y^{G,B1,E} = \frac{N_y^{B1,E}}{N_y^{B1} + p_2 N_y^{B2}}$ $p_y^{WSA,B1,E} = \frac{N_y^{B1,E}}{N_y^{B1,E} + N_y^{B2}} \quad \text{and} \quad p_y^{WSA,B2} = \frac{N_y^{B2}}{N_y^{B1,E} + N_y^{B2}}$ <p>and <math>p_1</math> is the proportion of B2 animals that migrate to the Antarctic, while <math>p_2</math> is the probability of sighting (or catching) a B2 animal as it transits through the Gabon breeding area relative to the probability for a B1 animal in that area.</p>
Gabon/WSA numbers	<p>Gabon: <math>N_y^{B1} + p_2 N_y^{B2}</math></p> <p>WSA: <math>N_y^{B2} + N_y^{B1,E}</math></p>



### Model Ie



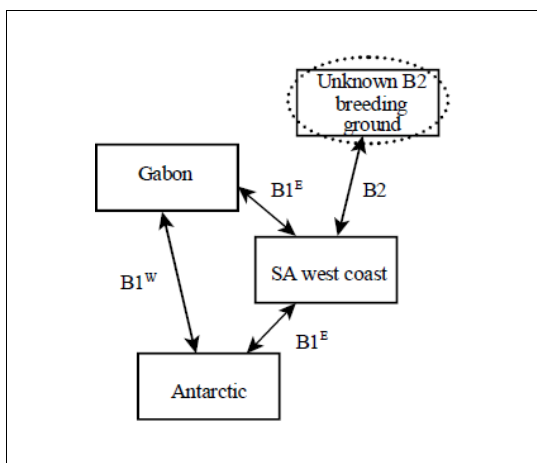
#### Model description

Model Ie is a variant of Model Ic in which some proportion (set here at 0.25) of sub-stock B1 migrates through Gabon to a separate unidentified breeding area. Given the carrying capacity for B1, the carrying capacities for its sub-stocks are given by:

$$K^{BS1,W} = XK^{BS1} \quad \text{and} \quad K^{BS1,E} = (1-X)K^{BS1}$$

**Table A1.7:** Breeding stock dynamics and catch equations for Model Ie. Equations for the numbers of whales off Gabon/WSA are also given. These are the groups to which the capture-recapture data and  $N_{min}$  constraints apply.

<i>Breeding stock population dynamics:</i>	$N_{y+1}^{B1,W} = N_y^{B1,W} + r^{B1} N_y^{B1,W} \left[ 1 - \left[ \frac{N_y^{B1,W} + N_y^{B1,E}}{K^{B1}} \right]^\mu \right] - C_y^{B1,W} \quad (\text{A1.31})$
	$N_{y+1}^{B1,E} = N_y^{B1,E} + r^{B1} N_y^{B1,E} \left[ 1 - \left[ \frac{N_y^{B1,W} + N_y^{B1,E}}{K^{B1}} \right]^\mu \right] - C_y^{B1,E} \quad (\text{A1.32})$
	$N_{y+1}^{B2} = N_y^{B2} + r^{B2} N_y^{B2} \left[ 1 - \left[ \frac{N_y^{B2}}{K^{B2}} \right]^\mu \right] - C_y^{B2} \quad (\text{A1.33})$
<i>Catches:</i>	$C_y^{B1} = C_y^A + p_y^{G,B1} C_y^G \quad (\text{A1.34})$
	$C_y^{B1,W} = p_y^{B1,W} C_y^{B1} \quad (\text{A1.35})$
	$C_y^{B1,E} = p_y^{B1,E} C_y^{B1} + p_y^{WSA,B1,E} C_y^{WSA} \quad (\text{A1.36})$
	$C_y^{B2} = p_y^{WSA,B2} C_y^{WSA} + p_y^{G,B2} C_y^G \quad (\text{A1.37})$
	<p>where</p> $p_y^{B1,W} = \frac{N_y^{B1,W}}{N_y^{B1,W} + N_y^{B1,E}} \quad \text{and} \quad p_y^{B1,E} = \frac{N_y^{B1,E}}{N_y^{B1,W} + N_y^{B1,E}}$ $p_y^{G,B1} = \frac{0.75N_y^{B1} + p_2(0.25N_y^{B1})}{0.75N_y^{B1} + p_2(0.25N_y^{B1} + N_y^{B2})}$ $p_y^{G,B2} = \frac{p_2 N_y^{B2}}{0.75N_y^{B1} + p_2(0.25N_y^{B1} + N_y^{B2})}$ $p_y^{WSA,B1,E} = \frac{N_y^{B1,E}}{N_y^{B1,E} + N_y^{B2}} \quad \text{and} \quad p_y^{WSA,B2} = \frac{N_y^{B2}}{N_y^{B1,E} + N_y^{B2}}$ <p>and <math>p_2</math> is the probability of sighting (or catching) a B2 animal as it transits through the Gabon breeding area relative to the probability for a B1 animal in that area.</p>
<i>Gabon/WSA numbers</i>	<p>Gabon: <math>0.75N_y^{B1} + p_2(0.25N_y^{B1} + N_y^{B2})</math></p> <p>WSA: <math>N_y^{B2} + N_y^{B1,E}</math></p>

**Model IIb***Model description*

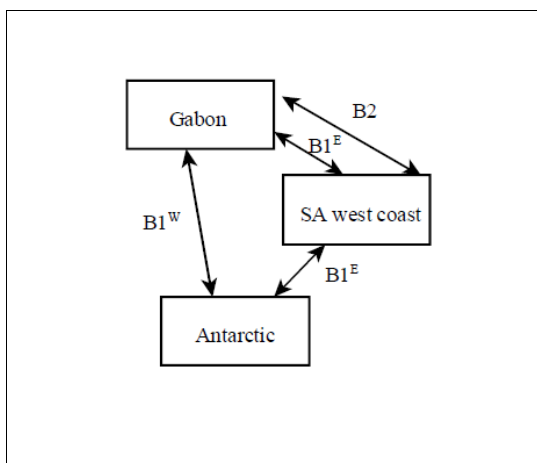
Model IIb is a variant of Model IIa which assumes two breeding stocks, B1 and B2. B1 is assumed to have two components, B1<sup>E</sup> and B1<sup>W</sup>. B1<sup>W</sup> migrates directly to Gabon from Antarctic feeding grounds while B1<sup>E</sup> migrates through waters off WSA before continuing on to the Gabon breeding grounds. B2 feeds off WSA, does not migrate through the Gabon breeding ground and migrates to a separate unidentified breeding area. Given the carrying capacity for B1, the carrying capacities for its sub-stocks are given by:

$$K^{BS1,W} = XK^{BS1} \quad \text{and} \quad K^{BS1,E} = (1-X)K^{BS1}$$

**Table A1.8:** Breeding stock dynamics and catch equations for Model IIb. Equations for the numbers of whales off Gabon/WSA are also given. These are the groups to which the capture-recapture data and  $N_{min}$  constraints apply.

<i>Breeding stock population dynamics:</i>	$N_{y+1}^{B1,W} = N_y^{B1,W} + r^{B1} N_y^{B1,W} \left[ 1 - \left[ \frac{N_y^{B1,W} + N_y^{B1,E}}{K^{B1}} \right]^\mu \right] - C_y^{B1,W} \quad (\text{A1.38})$
	$N_{y+1}^{B1,E} = N_y^{B1,E} + r^{B1} N_y^{B1,E} \left[ 1 - \left[ \frac{N_y^{B1,W} + N_y^{B1,E}}{K^{B1}} \right]^\mu \right] - C_y^{B1,E} \quad (\text{A1.39})$
	$N_{y+1}^{B2} = N_y^{B2} + r^{B2} N_y^{B2} \left[ 1 - \left[ \frac{N_y^{B2}}{K^{B2}} \right]^\mu \right] - C_y^{B2} \quad (\text{A1.40})$
<i>Catches:</i>	$C_y^{B1,W} = p_y^{A,B1,W} C_y^A + p_y^{G,B1,W} C_y^G \quad (\text{A1.41})$
	$C_y^{B1,E} = p_y^{A,B1,E} C_y^A + p_y^{WSA,B1,E} C_y^{WSA} + p_y^{G,B1,E} C_y^G \quad (\text{A1.42})$
	$C_y^{B2} = p_y^{WSA,B2} C_y^{WSA} \quad (\text{A1.43})$
	<p>where</p> $p_y^{A,B1,W} = \frac{N_y^{B1,W}}{N_y^{B1,W} + N_y^{B1,E}}$ $p_y^{A,B1,E} = \frac{N_y^{B1,E}}{N_y^{B1,W} + N_y^{B1,E}}$ $p_y^{G,B1,W} = \frac{N_y^{B1,W}}{N_y^{B1,W} + N_y^{B1,E}} \quad \text{and} \quad p_y^{G,B1,E} = \frac{N_y^{B1,E}}{N_y^{B1,W} + N_y^{B1,E}}$ $p_y^{WSA,B1,E} = \frac{N_y^{B1,E}}{N_y^{B1,E} + N_y^{B2}} \quad \text{and} \quad p_y^{WSA,B2} = \frac{N_y^{B2}}{N_y^{B1,E} + N_y^{B2}}$
<i>Gabon/WSA numbers</i>	<p>Gabon: <math>N_y^{B1,W} + N_y^{B1,E}</math>          WSA: <math>N_y^{B2} + N_y^{B1,E}</math>.</p>

### Model IV



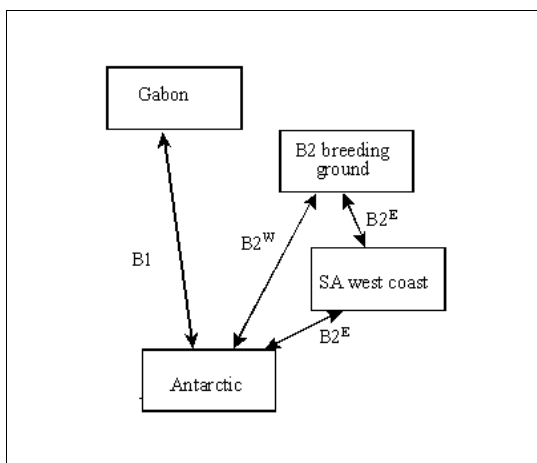
#### Model description

Model IV is a variant of Model IIa which assumes two breeding stocks, B1 and B2. B1 is assumed to have two components, B1<sup>E</sup> and B1<sup>W</sup>. B1<sup>W</sup> migrates directly to Gabon from Antarctic feeding grounds while B1<sup>E</sup> migrates through waters off WSA before continuing on to the Gabon breeding grounds. B2 feeds off WSA, does not migrate through the Gabon breeding ground and migrates to a separate unidentified breeding area. Given the carrying capacity for B1, the carrying capacities for its sub-stocks are given by:

$$K^{BS1,W} = XK^{BS1} \quad \text{and} \quad K^{BS1,E} = (1-X)K^{BS1}$$

**Table A1.9:** Breeding stock dynamics and catch equations for Model IV. Equations for the numbers of whales off Gabon/WSA are also given. These are the groups to which the capture-recapture data and  $N_{min}$  constraints apply.

<i>Breeding stock population dynamics:</i>	$N_{y+1}^{B1,W} = N_y^{B1,W} + r^{B1} N_y^{B1,W} \left[ 1 - \left[ \frac{N_y^{B1,W} + N_y^{B1,E}}{K^{B1}} \right]^\mu \right] - C_y^{B1,W} \quad (\text{A1.44})$
	$N_{y+1}^{B1,E} = N_y^{B1,E} + r^{B1} N_y^{B1,E} \left[ 1 - \left[ \frac{N_y^{B1,W} + N_y^{B1,E}}{K^{B1}} \right]^\mu \right] - C_y^{B1,E} \quad (\text{A1.45})$
	$N_{y+1}^{B2} = N_y^{B2} + r^{B2} N_y^{B2} \left[ 1 - \left[ \frac{N_y^{B2}}{K^{B2}} \right]^\mu \right] - C_y^{B2} \quad (\text{A1.46})$
<i>Catches:</i>	$C_y^{B1,W} = p_y^{A,B1,W} C_y^A + p_y^{G,B1,W} C_y^G \quad (\text{A1.47})$
	$C_y^{B1,E} = p_y^{A,B1,E} C_y^A + p_y^{WSA,B1,E} C_y^{WSA} + p_y^{G,B1,E} C_y^G \quad (\text{A1.48})$
	$C_y^{B2} = p_y^{G,B2} C_y^G + p_y^{WSA,B2} C_y^{WSA} \quad (\text{A1.49})$
	<p>where</p> $p_y^{A,B1,W} = \frac{N_y^{B1,W}}{N_y^{B1,W} + N_y^{B1,E}} \quad \text{and} \quad p_y^{A,B1,E} = \frac{N_y^{B1,E}}{N_y^{B1,W} + N_y^{B1,E}}$ $p_y^{G,B1,W} = \frac{N_y^{B1,W}}{N_y^{B1} + N_y^{B2}} \quad \text{and} \quad p_y^{G,B1,E} = \frac{N_y^{B1,E}}{N_y^{B1} + N_y^{B2}}$ $p_y^{G,B2} = \frac{N_y^{B2}}{N_y^{B1} + N_y^{B2}}$ $p_y^{WSA,B1,E} = \frac{N_y^{B1,E}}{N_y^{B1,E} + N_y^{B2}} \quad \text{and} \quad p_y^{WSA,B2} = \frac{N_y^{B2}}{N_y^{B1,E} + N_y^{B2}}$
<i>Gabon/WSA numbers</i>	<p>Gabon: <math>N_y^{B1} + N_y^{B2}</math>          WSA: <math>N_y^{B2} + N_y^{B1,E}</math></p>

**Model V***Model description*

Model V allocates the Angolan catches (otherwise allocated to Gabon for the reference case) to the catches off WSA. The model has stock B2 breeding off Angola, and splits this into two sub-stocks (B2<sup>W</sup> and B2<sup>E</sup>) where only the latter visits the area off WSA to which capture-recapture data relate. Some proportion of the B2<sup>E</sup> population migrates to the Antarctic. Given the carrying capacity for B2, the carrying capacities for its sub-stocks are given by:

$$K^{B2,W} = XK^{B2} \quad \text{and} \quad K^{B2,E} = (1-X)K^{B2}$$

**Table A1.10:** Breeding stock dynamics and catch equations for Model V. Equations for the numbers of whales off Gabon/WSA are also given. These are the groups to which the capture-recapture data and  $N_{min}$  constraints apply.

<i>Breeding stock population dynamics:</i>	$N_{y+1}^{B1} = N_y^{B1} + r^{B1} N_y^{B1} \left[ 1 - \left[ \frac{N_y^{B1}}{K^{B1}} \right]^\mu \right] - C_y^{B1} \quad (\text{A1.50})$ $N_{y+1}^{B2,W} = N_y^{B2,W} + r^{B2} N_y^{B2,W} \left[ 1 - \left[ \frac{N_y^{B2,W} + N_y^{B2,E}}{K^{B2}} \right]^\mu \right] - C_y^{B2,W} \quad (\text{A1.51})$ $N_{y+1}^{B2,E} = N_y^{B2,E} + r^{B2} N_y^{B2,E} \left[ 1 - \left[ \frac{N_y^{B2,W} + N_y^{B2,E}}{K^{B2}} \right]^\mu \right] - C_y^{B2,E} \quad (\text{A1.52})$
<i>Catches:</i>	$C_y^{B1} = p_y^{A,B1} C_y^A + C_y^G \quad (\text{A1.53})$ $C_y^{B2,W} = p_y^{A,B2,W} C_y^A + p_y^{WSA,B2,W} C_y^{WSA} \quad (\text{A1.54})$ $C_y^{B2,E} = p_y^{A,B2,E} C_y^A + p_y^{WSA,B2,E} C_y^{WSA} \quad (\text{A1.55})$ <p>where</p> $p_y^{A,B1} = \frac{N_y^{B1}}{N_y^{B1} + N_y^{B2,W} + p_1 N_y^{B2,E}}$ $p_y^{A,B2,W} = \frac{N_y^{B2,W}}{N_y^{B1} + N_y^{B2,W} + p_1 N_y^{B2,E}} \quad \text{and} \quad p_y^{A,B2,E} = \frac{p_1 N_y^{B2,E}}{N_y^{B1} + N_y^{B2,W} + p_1 N_y^{B2,E}}$ $p_y^{WSA,B2,W} = \frac{N_y^{B2,W}}{N_y^{B2,W} + N_y^{B2,E}} \quad \text{and} \quad p_y^{WSA,B2,E} = \frac{N_y^{B2,E}}{N_y^{B2,W} + N_y^{B2,E}}$ <p>where <math>p_1</math> is the proportion of B2<sup>E</sup> animals that migrate down to the Antarctic.</p>
<i>Gabon/WSA numbers</i>	<p>Gabon: <math>N_y^{B1}</math>          WSA: <math>N_y^{B2,E}</math></p>

**Table A1.11(a):** Details of the SEN1a-SEN4 as recommend at IWC SC 62 in Agadir. The highlighted blocks indicate the assumption under investigation for the sensitivity concerned.

Data category	Pop <sup>n</sup>	Reference Case assumptions	SEN 1a	SEN 1b	SEN 1c	SEN 2b	SEN 3a	SEN 3b	SEN 4
Model applied to			RC IIIa	RC IIIa	RC IIIa	RC IIIa	RC IIa**	RC IIa**	RC IIIa
Capture-recapture	Gabon	Microsatellites (males only, two sites)	Microsatellite (both sexes, two sites)	Flukes (two sites)	Flukes (two sites)	Microsatellites (males only)	Microsatellites (males only)	Microsatellites (males only)	Microsatellites (males only)
	WSA	Microsatellites	Microsatellite	Flukes	Right dorsal fin	Microsatellites	Microsatellites	Microsatellites	Microsatellites
$N_{min}$	Gabon	4 x #haplotypes = 516	4 x #haplotypes = 516	4 x #haplotypes = 516	4 x #haplotypes = 516	4 x #haplotypes = 516	4 x #haplotypes = 516	4 x #haplotypes = 516	4 x #haplotypes = 516
	WSA	4 x # haplotypes = 284	4 x # haplotypes = 284	4 x # haplotypes = 284	4 x # haplotypes = 284	4 x # haplotypes = 284	4 x # haplotypes = 284	4 x # haplotypes = 284	4 x # haplotypes = 284
Catch allocation (north of 40°S)	Gabon	Congo and 50% Angola	Congo and 50% Angola	Congo and 50% Angola	Congo and 50% Angola	Congo and 0% Angola	Congo and 50% Angola	Congo and 50% Angola	Congo and 50% Angola
	WSA	50% Angola, Namibia and WSA	50% Angola, Namibia and WSA	50% Angola, Namibia and WSA	50% Angola, Namibia and WSA	100% Angola, Namibia and WSA	50% Angola, Namibia and WSA	50% Angola, Namibia and WSA	50% Angola, Namibia and WSA
Catch allocation (south of 40°S)	Gabon	Hypothesis 1 <sup>†</sup>	Hypothesis 1	Hypothesis 1	Hypothesis 1	Hypothesis 1	Hypothesis 1	Hypothesis 1	Hypothesis 1
	WSA	Hypothesis 1	Hypothesis 1	Hypothesis 1	Hypothesis 1	Hypothesis 1	Hypothesis 1	Hypothesis 1	Hypothesis 1
Migration of B2 to unknown breeding ground	WSA	25% (for Model Ie)	N/A	N/A	N/A	N/A	N/A	N/A	N/A
Migration of B2 to Antarctic	WSA	50% (for Model Ia, IIa, IIIa, Id) <sup>††</sup>	50%	50%	50%	50%	100%	0%	50%
Struck and loss rate	Both	0.15*	0.15	0.15	0.15	0.15	0.15	0.15	0

<sup>†</sup> Hypothesis 1 assumes that each of the seven Southern Hemisphere breeding stocks is associated with a nucleus and a margin region in the Antarctic feeding grounds. Catches in the nucleus regions are allocated entirely to the corresponding stocks, while catches in the margin regions are split in a 50:50 ratio between neighbouring stocks (see SC/61/SH31 and Annex H of the report of the 2009 IWC annual meeting).

<sup>††</sup> Note that Table 4 of Annex H of the 2010 IWC SC report states that this migration to the Antarctic applies to Model Ie. We assume that this applies also to Model Ia, IIa and IIIa, for which there is also a proportion of B2 animals that migrate to the Antarctic.

\* The struck and loss rate has been applied to pre-1914 catches.

\*\* Note that Model IIIa does not have a B2 component migrating to the Antarctic. As such, it cannot be used for this sensitivity test, and Model IIa is used instead.

**Table A1.11(b):** Details of SEN5 – SEN 7, proposed intersessionally after the Agadir meeting. The highlighted blocks indicate the assumption under investigation.

Data category	Pop <sup>n</sup>	Reference case assumptions	SEN 5	SEN 6	SEN 7
<b>Model applied to</b>			<b>RC IIIa</b>	<b>RC IIIa</b>	<b>RC IIIa</b>
<b>Capture-recapture</b>	Gabon	Microsatellites (males only, two sites)	<b>Flukes: / all sites</b>	Microsatellites (males only)	Microsatellites (males only)
	WSA	Microsatellites	<b>Flukes</b>	Microsatellites	Microsatellites
$N_{min}$	Gabon	4 x #haplotypes = 516	4 x #haplotypes = 516	<b>#haplotypes+1 = 130</b>	<b>4 x #haplotypes = 516</b>
	WSA	4 x # haplotypes = 284	4 x # haplotypes = 284	<b>#haplotypes+1=72</b>	<b>4 x # unique haplotypes = 24</b>
<b>Catch allocation (north of 40°S)</b>	Gabon	Congo and 50% Angola	Congo and 50% Angola	Congo and 50% Angola	Congo and 50% Angola
	WSA	50% Angola, Namibia and WSA	50% Angola, Namibia and WSA	50% Angola, Namibia and WSA	50% Angola, Namibia and WSA
<b>Catch allocation (south of 40°S)</b>	Gabon	Hypothesis 1	Hypothesis 1	Hypothesis 1	Hypothesis 1
	WSA	Hypothesis 1	Hypothesis 1	Hypothesis 1	Hypothesis 1
<b>Migration to unknown breeding ground</b>	WSA	25% (for Model Ie)	N/A	N/A	N/A
<b>Migration to Antarctic</b>	WSA	50% (for Model Ia, IIa, IIIa, Id)	50%	50%	50%
<b>Struck and loss rate</b>	Both	0.15	0.15	0.15	0.15

## Appendix 2

This appendix lists the available catch and capture-recapture data used in the assessments presented in this document.

**Table A2.1:** Catches north of 40°S (C. Allison, *pers. comm.*).

Year	Congo	Congo /Ang	Angola	Namib	SWCap	Russian	Reference case		SEN 2b and Model V	
							Gabon population	WSA population	Gabon population	WSA population
1900	0	0	0	0	0	0	0	0	0	0
1901	0	0	0	0	0	0	0	0	0	0
1902	0	0	0	0	0	0	0	0	0	0
1903	0	0	0	0	0	0	0	0	0	0
1904	0	0	0	0	0	0	0	0	0	0
1905	0	0	0	0	0	0	0	0	0	0
1906	0	0	0	0	0	0	0	0	0	0
1907	0	0	0	0	0	0	0	0	0	0
1908	0	0	0	0	0	0	0	0	0	0
1909	0	0	269	0	307	0	134.5	441.5	0	576
1910	0	0	718	0	244	0	359.0	603.0	0	962
1911	0	0	2264	0	339	0	1132.0	1471.0	0	2603
1912	418	0	3499	559	216	0	2167.5	2524.5	418	4274
1913	2227	0	3084	521	130	0	3769.0	2193.0	2227	3735
1914	1843	0	772	204	54	0	2229.0	644.0	1843	1030
1915	0	0	164	0	5	0	82.0	87.0	0	169
1916	0	0	66	0	4	0	33.0	37.0	0	70
1917	0	0	0	0	10	0	0	10.0	0	10
1918	0	0	0	0	10	0	0	10.0	0	10
1919	0	0	0	0	17	0	0	17.0	0	17
1920	0	0	0	0	40	0	0	40.0	0	40
1921	0	0	0	0	0	0	0	0	0	0
1922	613	0	0	0	13	0	613.0	13.0	613	13
1923	685	0	2	199	13	0	686.0	213.0	685	214
1924	519	0	47	77	19	0	542.5	119.5	519	143
1925	756	0	17	60	9	0	764.5	77.5	756	86
1926	321	0	6	96	19	0	324.0	118.0	321	121
1927	0	0	3	32	12	0	1.5	45.5	0	47
1928	0	0	37	10	21	0	18.5	49.5	0	68
1929	0	0	0	10	40	0	0	50.0	0	50
1930	578	0	0	6	30	0	578.0	36.0	578	36
1931	0	0	0	0	0	0	0	0	0	0
1932	0	0	0	0	0	0	0	0	0	0
1933	0	0	0	0	0	0	0	0	0	0
1934	0	723	0	0	0	0	723.0	0	723	0
1935	549	689	0	0	0	0	1238.0	0	1238	0
1936	345	497	0	0	27	0	842.0	27.0	842	27
1937	0	299	0	0	28	0	299.0	28.0	299	28

1938	0	0	0	0	0	0	0	0	0	0	0
1939	0	0	0	0	0	0	0	0	0	0	0
1940	0	0	0	0	0	0	0	0	0	0	0
1941	0	0	0	0	0	0	0	0	0	0	0
1942	0	0	0	0	0	0	0	0	0	0	0
1943	0	0	0	0	0	0	0	0	0	0	0
1944	0	0	0	0	0	0	0	0	0	0	0
1945	0	0	0	0	0	0	0	0	0	0	0
1946	0	0	0	0	0	0	0	0	0	0	0
1947	0	0	0	0	5	0	0	5	0	5	0
1948	0	0	0	0	14	0	0	14.0	0	14	0
1949	1356	0	0	0	15	0	1356.0	15.0	1356	15	0
1950	1404	0	0	0	7	0	1404.0	7.0	1404	7	0
1951	1105	0	0	0	9	0	1105.0	9.0	1105	9	0
1952	265	0	0	0	15	0	265.0	15.0	265	15	0
1953	0	0	0	0	9	0	0	9.0	0	9	0
1954	0	0	0	0	0	0	0	0	0	0	0
1955	0	0	0	0	0	0	0	0	0	0	0
1956	0	0	0	0	0	0	0	0	0	0	0
1957	0	0	0	0	3	0	0	3.0	0	3	0
1958	0	0	0	0	2	0	0	2.0	0	2	0
1959	161	0	0	0	7	0	161.0	7.0	161	7	0
1960	0	0	0	0	4	0	0	4.0	0	4	0
1961	0	0	0	0	4	3	0	7.0	0	7	0
1962	0	0	0	0	9	6	0	15.0	0	15	0
1963	0	0	0	0	3	6	0	9.0	0	9	0
1964	0	0	0	0	0	1	0	1.0	0	1	0
1965	0	0	0	0	0	1	0	1.0	0	1	0
1966	0	0	0	0	0	9	0	9.0	0	9	0
1967	0	0	0	0	0	3	0	3.0	0	3	0
1968	0	0	0	0	0	0	0	0	0	0	0
1969	0	0	0	0	0	0	0	0	0	0	0
	13145	2208	10948	1774	1713	29	20827	8990	15353	14464	0

**Table A2.2:** Russian catches taken north of 40°S (C. Allison, *pers. comm.*).

	Namibia				WSA			
	19-10W	9-0W	0-9E	<b>Total</b>	19-10W	9-0W	0-9E	<b>Total</b>
1961	0	0	3	<b>3</b>	0	0	0	<b>0</b>
1962	0	0	2	<b>2</b>	0	2	2	<b>4</b>
1963	2	0	1	<b>3</b>	0	2	1	<b>3</b>
1964	0	0	0	<b>0</b>	0	0	1	<b>1</b>
1965	0	0	0	<b>0</b>	1	0	0	<b>1</b>
1966	0	0	0	<b>0</b>	0	9	0	<b>9</b>
1967	0	0	0	<b>0</b>	0	3	0	<b>3</b>
<b>Total</b>	<b>2</b>	<b>0</b>	<b>6</b>	<b>8</b>	<b>1</b>	<b>16</b>	<b>4</b>	<b>21</b>



**Table A2.3:** Catches south of 40°S (C. Allison, *pers. commn*).

	A/B	B	B	B/C	B/C	Total
	19-10W	9-0W	0-9E	10-19E	20-29E	
1903	0	0	0	0	0	<b>0</b>
1904	0	0	0	0	0	<b>0</b>
1905	0	0	0	0	0	<b>0</b>
1906	0	0	0	0	0	<b>0</b>
1907	0	0	0	0	0	<b>0</b>
1908	0	0	0	0	0	<b>0</b>
1909	0	0	0	0	0	<b>0</b>
1910	0	0	0	0	0	<b>0</b>
1911	0	0	0	0	0	<b>0</b>
1912	0	0	0	0	0	<b>0</b>
1913	0	0	0	0	0	<b>0</b>
1914	0	0	0	0	0	<b>0</b>
1915	0	0	0	0	0	<b>0</b>
1916	0	0	0	0	0	<b>0</b>
1917	0	0	0	0	0	<b>0</b>
1918	0	0	0	0	0	<b>0</b>
1919	0	0	0	0	0	<b>0</b>
1920	0	0	0	0	0	<b>0</b>
1921	0	0	0	0	0	<b>0</b>
1922	0	0	0	0	0	<b>0</b>
1923	0	0	0	0	0	<b>0</b>
1924	0	0	0	0	0	<b>0</b>
1925	0	0	0	0	0	<b>0</b>
1926	0	0	0	0	0	<b>0</b>
1927	0	0	0	0	0	<b>0</b>
1928	0	0	0	0	0	<b>0</b>
1929	9.00	3.00	5.00	1.00	3.00	<b>14.50</b>
1930	26.00	10.00	27.00	1.00	110.00	<b>105.50</b>
1931	1.00	0	2.00	0	0	<b>2.50</b>
1932	2.00	7.00	9.00	0	9.00	<b>21.50</b>
1933	38.00	36.00	11.00	0	9.00	<b>70.50</b>
1934	14.00	23.00	1.00	2.00	263.00	<b>163.50</b>
1935	201.00	80.00	19.00	226.00	1292.00	<b>958.50</b>
1936	88.00	67.00	95.00	431.00	1959.00	<b>1401.00</b>
1937	65.00	42.00	81.00	96.00	402.00	<b>404.50</b>
1938	0	0	0	0	0	<b>0</b>
1939	0	0	0	0	4.00	<b>2</b>
1940	111.00	81.00	50.00	0	0	<b>186.50</b>
1941	0	0	0	0	0	<b>0</b>
1942	0	0	0	0	0	<b>0</b>
1943	0	0	0	0	0	<b>0</b>
1944	0	0	0	0	0	<b>0</b>
1945	0	0	0	0	0	<b>0</b>
1946	1.00	0	0	0	0	<b>0.50</b>

1947	1.00	0	0	0	0	<b>0.50</b>
1948	38.10	20.60	24.80	27.20	6.00	<b>81.05</b>
1949	257.50	110.50	97.30	202.70	148.00	<b>511.90</b>
1950	27.90	76.30	124.70	52.90	17.00	<b>249.90</b>
1951	114.90	175.80	137.20	204.60	5.00	<b>475.25</b>
1952	33.40	45.40	122.70	113.80	80.10	<b>281.75</b>
1953	31.20	31.60	38.20	47.70	4.00	<b>111.25</b>
1954	52.10	123.80	141.60	23.30	19.00	<b>312.60</b>
1955	83.20	24.50	35.70	9.40	13.00	<b>113.00</b>
1956	65.20	25.50	5.00	0	0	<b>63.10</b>
1957	32.40	6.00	22.00	25.00	30.30	<b>71.85</b>
1958	6.50	4.40	76.20	35.70	19.60	<b>111.50</b>
1959	7.70	6.60	46.40	38.00	92.00	<b>121.85</b>
1960	4.00	2.40	110.80	21.80	5.20	<b>128.70</b>
1961	0	3.00	15.00	21.00	4.00	<b>30.50</b>
1962	4.00	0	10.00	7.00	12.00	<b>21.50</b>
1963	0	0	2.00	0	0	<b>2.00</b>
1964	0	0	0	0	0	<b>0</b>
1965	34.00	666.00	214.00	59.00	5.00	<b>929.00</b>
1966	0	80.00	67.00	91.00	46.00	<b>215.50</b>
1967	6.00	317.00	42.00	26.00	9.00	<b>379.50</b>
1968	0	0	0	0	0	<b>0</b>
1969	0	0	0	0	0	<b>0</b>
1970	0	0	0	0	0	<b>0</b>
1971	0	0	0	0	0	<b>0</b>
1972	0	0	1.00	0	0	<b>1.00</b>
1973	0	0	0	0	0	<b>0</b>
1974	0	0	0	0	0	<b>0</b>
1975	0	0	0	0	0	<b>0</b>
1976	0	0	0	0	0	<b>0</b>
1977	0	0	0	0	0	<b>0</b>
1978	0	0	0	0	0	<b>0</b>
1979	0	0	0	0	0	<b>0</b>
Total	1355.1	2068.4	1633.6	1763.1	4566.2	<b>7544.2</b>

**Table A2.4:** Gabon microsatellites, Iguela and Mayumba only, males only (T. Collins, *pers. commn*).  
[ $n$  = number of different individuals sighted each year,  $m$  = total recaptures between pairs of years]

$n$	2001	2002	2003	2004	2005	2006
	115	94	197	149	184	133

$m$	2001	2002	2003	2004	2005	2006
2001	X	2	7	3	2	2
2002		X	3	1	2	1
2003			X	6	6	1
2004				X	9	3
2005					X	7
2006						X

**Table A2.5:** Gabon microsatellites, Iguela and Mayumba only, both sexes (T. Collins, *pers. commn*).  
[ $n$  = number of different individuals sighted each year,  $m$  = total recaptures between pairs of years]

$n$	2001	2002	2003	2004	2005	2006
	155	167	274	215	304	209

$m$	2001	2002	2003	2004	2005	2006
2001	X	4	8	6	4	2
2002		X	5	2	5	1
2003			X	8	7	1
2004				X	11	3
2005					X	11
2006						X

**Table A2.6:** Gabon microsatellites, all sites, males only (T. Collins, *pers. commn*).  
[ $n$  = number of different individuals sighted each year,  $m$  = total recaptures between pairs of years]

$n$	2000	2001	2002	2003	2004	2005	2006
	59	115	158	197	149	183	133

$m$	2000	2001	2002	2003	2004	2005	2006
2000	X	1	1	4	2	3	0
2001		X	4	7	3	2	2
2002			X	5	4	3	3
2003				X	6	6	1
2004					X	9	3
2005						X	7
2006							X

**Table A2.7:** Gabon microsatellites, all sites, both sexes (T. Collins, *pers. commn*).[ $n$  = number of different individuals sighted each year,  $m$  = total recaptures between pairs of years]

$n$	2000	2001	2002	2003	2004	2005	2006
	82	155	257	274	215	304	209

$m$	2000	2001	2002	2003	2004	2005	2006
2000	X	1	1	4	2	3	0
2001		X	6	8	6	3	2
2002			X	7	6	6	4
2003				X	8	7	1
2004					X	11	3
2005						X	11
2006							X

**Table A2.8:** Gabon fluke photo-ID (total sample from two sites, Iguela and Mayumba (S. Cerchio, *pers. commn*)).[ $n$  = number of different individuals sighted each year,  $m$  = total recaptures between pairs of years]

Year	2001	2002	2003	2004	2005	2006
$N$	111	143	161	140	219	214

$M$	2001	2002	2003	2004	2005	2006
2001	X	4	6	5	2	1
2002		X	6	0	2	2
2003			X	8	2	1
2004				X	4	2
2005					X	9
2006						X

**Table A2.9:** Gabon fluke photo-ID (total sample from all sites) (Collins *et al.*, 2008).[ $n$  = number of different individuals sighted each year,  $m$  = total recaptures between pairs of years]

$n$	2000	2001	2002	2003	2004	2005	2006
	24	111	233	161	138	216	199

$m$	2000	2001	2002	2003	2004	2005	2006
2000	X	0	1	0	0	0	0
2001		X	5	6	5	2	1
2002			X	12	2	2	4
2003				X	7	2	1
2004					X	2	2
2005						X	6
2006							X

**Table A2.10:** WSA genetic capture-recapture data based on microsatellite matches (Barendse *et al.*, 2010).  
 [ $n$  = number of different individuals sighted each year,  $m$  = total recaptures between pairs of years]

$n$	2001	2002	2003	2004	2005	2006
	39	58	14	20	25	27

$m$	2001	2002	2003	2004	2005	2006
2001	X	9	1	1	1	1
2002		X	1	5	0	1
2003			X	1	1	1
2004				X	1	2
2005					X	1

**Table A2.11:** WSA photo-ID capture-recapture data based on right-dorsal fin features (Barendse *et al.*, 2010).

$n$	2001	2002	2003	2004	2005	2006
	39	58	14	20	25	27

$m$	2001	2002	2003	2004	2005	2006
2001	X	7	1	2	0	1
2002		X	0	4	2	2
2003			X	0	0	0
2004				X	1	0
2005					X	0
2006						X

**Table A2.12:** WSA photo-ID capture-recapture data based on fluke fin features (J. Barendse, *pers. comm.*).  
 [ $n$  = number of different individuals sighted each year,  $m$  = total recaptures between pairs of years]

$n$	2001	2002	2003	2004	2005	2006
	15	16	10	7	9	16

$m$	2001	2002	2003	2004	2005	2006
2001	X	3	1	0	0	0
2002		X	0	1	0	1
2003			X	1	0	0
2004				X	0	0
2005					X	1
2006						X